



Technology for Vacuum Systems

CHEMISTRY PUMPING UNIT SERIES

PC 3001 VARIO select
PC 3001 VARIO select TE
PC 3001 VARIO select IK
PC 3001 VARIO select EKP



Instructions for use

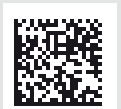

**Original instructions
Keep for further use!**

This manual is only to be used and distributed in its complete and original form. It is strictly the user's responsibility to carefully check the validity of this manual with respect to the product.

Manufacturer:
VACUUBRAND GMBH + CO KG
Alfred-Zippe-Str. 4
97877 Wertheim
GERMANY

Phone:

- Head office +49 9342 808-0
- Sales +49 9342 808-5550
- Service +49 9342 808-5660

Fax: +49 9342 808-5555
E-Mail: info@vacuubrand.com
Web: www.vacuubrand.com

*Thank you for purchasing this product from **VACUUBRAND GMBH + CO KG** . You have chosen a modern and technically high quality product.*

TABLE OF CONTENT

1	Introduction	5
1.1	User information	5
1.2	About this document.	6
1.2.1	Manual structure	6
1.2.2	Display conventions	7
1.2.3	Symbols and icons	8
1.2.4	Handling instructions (action steps).	9
1.2.5	Abbreviations	9
1.2.6	Term definitions.	10
2	Safety information	12
2.1	Usage.	12
2.1.1	Intended use	12
2.1.2	Improper use.	13
2.1.3	Foreseeable misuse.	13
2.2	Obligations	14
2.2.1	Operator obligations	14
2.2.2	Personnel obligations	14
2.3	Target group description.	15
2.4	Safety precautions, general	16
2.4.1	Protective clothing.	16
2.4.2	Safety precautions	16
2.4.3	Laboratory and working materials.	17
2.4.4	Eliminate sources of danger	18
2.5	Motor protection	21
2.6	ATEX equipment category	22
2.7	Proper disposal	23
3	Product description	24
3.1	PC 3001 VARIO select (basic design).	24
3.2	Chemistry pumping units	25
3.3	Condensers and coolers	26
3.3.1	Separator / Condenser at the inlet	26
3.3.2	Condenser at the outlet.	27
3.4	Examples of use.	29
4	Installation and connection	30
4.1	Transport	30
4.2	Installation	31

4.3	Connection	32
4.3.1	Vacuum connection (IN)	32
4.3.2	Exhaust gas connection (EX)	34
4.3.3	Coolant connection at the condenser	35
4.3.4	Dry ice condenser	36
4.3.5	Venting connection	39
4.3.6	Gas ballast (GB)	41
4.3.7	Electrical connection	42
5	Initial use (operation)	44
5.1	Switch on	44
5.2	Operation	44
5.2.1	Operation (→ see description of controller)	46
5.2.2	Operation with gas ballast	47
5.3	Decommissioning (switch off)	48
5.4	Storage	49
6	Troubleshooting	50
6.1	Technical support	50
6.2	Error – Cause – Remedy	50
7	Cleaning and maintenance	54
7.1	Information on service work	55
7.2	Cleaning	57
7.2.1	Housing surface	57
7.2.2	Empty glass flask	57
7.2.3	Clean sensor and venting valve	58
7.2.4	Clean or replace molded PTFE-hose	61
7.3	Vacuum pump maintenance	62
7.3.1	Maintenance items	62
7.3.2	Change diaphragms and valves	64
8	Appendix	74
8.1	Technical information	74
8.1.1	Technical data	74
8.1.2	Wetted materials	76
8.1.3	Rating plate	77
8.2	Ordering information	78
8.3	Service	80
8.4	Index	81
8.5	EC Declaration of Conformity	83

1 Introduction

This manual is part of your product. The manual applies to all variants of the pumping unit, together with the VACUU-SELECT® manual, and is intended in particular for laboratory staff.

1.1 User information

Safety

Instructions for use
and safety

- Read this manual thoroughly and completely before using the produkt.
- Keep this manual in an easily accessible location.
- Correct use of the product is essential for safe operation. Comply with all safety information provided!
- In addition to this manual, adhere to the accident prevention regulations and industrial safety regulations applicable in the country of use.

General

General
information

- For easier readability, the general term *pumping unit* is used as an equivalent to and instead of the product name *Chemistry pumping unit PC 3001 VARIO select*.
- If passing the product on to a third party, also give them this manual.
- The illustrations in this manual are only intended to facilitate comprehension.
- We reserve the right to make technical and design changes in the course of continuous product improvement.

Copyright

Copyright ©

The content of this manual is protected by copyright. Only copies for internal use are allowed, e. g., for professional training.

© **VACUUBRAND GMBH + CO KG**

Contact

Contact us

- If your manual is incomplete, you can request a replacement. Alternatively, you can use our download portal: www.vacuubrand.com
- You are welcome to contact us at any time in writing or by telephone if you would like more information, have questions about our products or wish to share feedback with us.
- When contacting our Service Department, please have the serial number and product type at hand → see *Rating plate on the product*.

1.2 About this document

1.2.1 Manual structure

Modular instructions for use

The manuals have a modular structure with separate instruction modules for the controller, vacuum pumps, pumping units, and any accessories.

Instruction modules

Pumping unit series and instructions for use

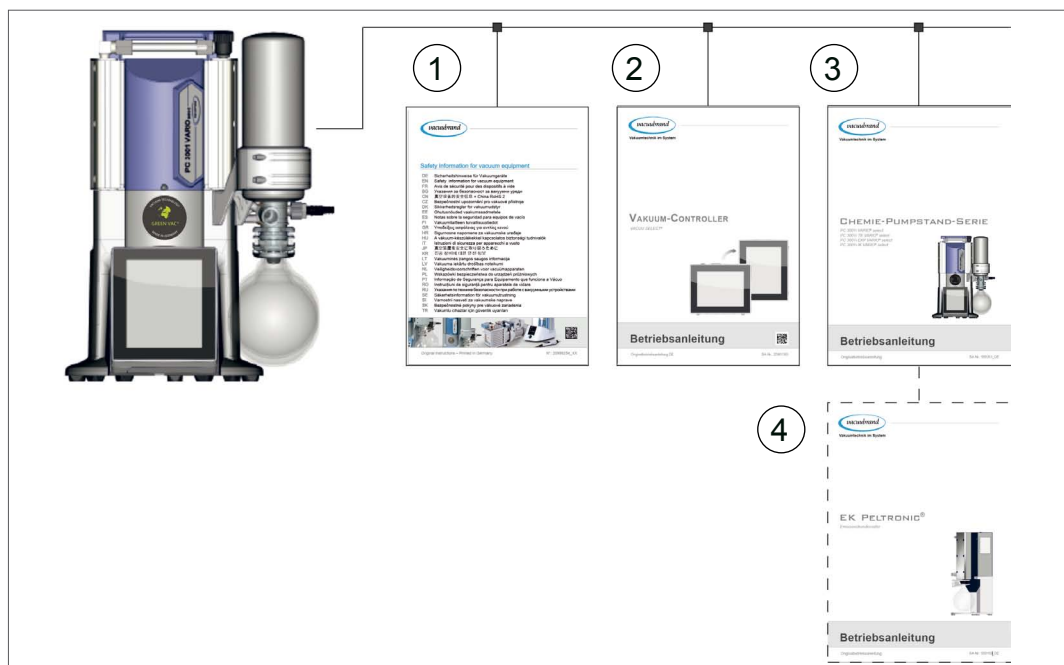

1 Safety Information for Vacuum Equipment

2 Description: Vacuum controller – control and operation

3 Description: Pumping unit – connection, operation, maintenance, mechanics

4 Optional description: Accessories

1.2.2 Display conventions

Warning levels

Display conventions

	DANGER
	<p>Indicates an imminent hazardous situation. Disregarding the situation will result in serious and even fatal injury or death.</p> <p>⇒ Take appropriate action to avoid dangerous situation!</p>

	WARNING
	<p>Indicates a potentially hazardous situation. Disregarding the situation could result in serious, even fatal injury or massive damage to property.</p> <p>⇒ Take appropriate action to avoid dangerous situation!</p>

	CAUTION
	<p>Indicates a potentially hazardous situation. Disregarding the situation could result in slight or minor injury or damage to property.</p> <p>⇒ Take appropriate action to avoid dangerous situation!</p>

NOTICE	
<p>Notice for a potentially harmful situation. Disregarding the notice could lead to material damage.</p>	

Additional notes

IMPORTANT!

- ⇒ Information or specific use recommendation, which must be observed.
- ⇒ Important information for proper operation.

	<ul style="list-style-type: none"> ⇒ Helpful tips + tricks ⇒ Additional notes
---	---

1.2.3 Symbols and icons

This manual uses symbols and icons. Safety symbols indicate specific risks associated with handling the product. Symbols and icons are designed to help you identify risks more easily.









Safety symbols

Explanation of safety symbols

	Hazardous substance - hazards to human health.		General prohibition sign.
	General warning sign.		Warning Risk of explosion.
	Danger: electricity		Danger: hot surface
	General mandatory sign.		Disconnect mains plug.
	Wear chemical resistant protective gloves.		Wear protective goggles.
	Read instructions for repair.		

Additional icons

Additional symbols

	Positive example – Do this! Result – OK		Negative example – Do not do this!
	Refers to content in this manual.		Refers to content of other supplementary documents.
	Installation at temperatures < 40 °C (< 104 °F).		Ensure sufficient air circulation.
	Flow arrow Inlet – vacuum connection		Flow arrow Outlet – exhaust gas

1.2.4 Handling instructions (action steps)

Display of action steps

Instructions (single step)

⇒ Perform the step described.

Result of action

Instructions (multiple steps)

1. First step

2. Next step

Result of action

Perform the steps in the order described.

1.2.5 Abbreviations

Abbreviations

abs.	Absolute
AK	Separator flask
ATM	Atmospheric pressure (pressure graphic, program)
d_i (di)	Interior diameter
DN	Nominal diameter
EK	Vapor condenser
EKP	Emission condenser Peltronic® or EK Peltronic®
EX*	Outlet (exhaust, exit), exhaust gas connection
	ATEX equipment labeling
FKM	Fluoroelastomer
GB	Gas ballast
Gr.	Size
IK	Inlet condenser
IN*	Inlet, vacuum connection
KF	Small flange
max.	Maximum value
min.	Minimum value
o. EK	without vapor condenser
PA	Polyamide
PBT	Polybutylene terephthalate
PC	Chemistry pumping unit with type identification number
PE	Polyethylene
RMA-N°	Return Merchandise Authorization number

Abbreviations	SW	Wrench size (tool)
	TE	Dry ice condenser
	resp.	responsible (supervising)
	e. g.,	for example

* Labeling on vacuum pump or component

→ see also *Product-specific abbreviations on page 25*

1.2.6 Term definitions

Product-specific terms

Separator flask	Glass flask / separator mounted at the inlet or outlet.
Vapor condenser*	Cooling condenser with receiving flask mounted at the outlet (pressure side).
Immission condenser*	Cooling condenser with receiving flask mounted at the inlet (vacuum side).
PC 3001 VARIO select	Vacuum pumping unit with speed control for precise vacuum regulation with controller VACUU-SELECT® .
Peltronic®	Electronic cooler with Peltier elements mounted at the outlet; condenses solvent vapors without external coolant.
Dry ice condenser*	Cooling condenser with receiving flask mounted at the outlet (pressure side) and dry ice as coolant.
VACUU-BUS®	Bus system from VACUUBRAND for communication between peripheral devices with VACUU-BUS® enabled gauges and controllers. The maximum permissible cable length is 30 m.
VACUU-BUS® address	Address which enables the VACUU-BUS® client to be unambiguously assigned within the bus system, e. g., for connecting multiple sensors with the same measurement range.
VACUU-BUS® client	Peripheral device or component with VACUU-BUS® port which is integrated in the bus system, e. g., sensors, valves, level indicators, etc.
VACUU-BUS® connector	4-pin round connector for the bus system from VACUUBRAND .
VACUU-BUS® configuration	Assigning a different VACUU-BUS® address to a VACUU-BUS® component using a gauge or controller.

Product-specific
terms

VACUU-SELECT®	Vacuum controller, controller with touchscreen; consisting of operating panel and vacuum sensor.
VACUU-SELECT® Sensor	Vacuum sensor with integrated venting valve.
VARIO® drive	Speed control for vacuum pump; the motor runs only as fast as necessary to meet demand.

** only suitable for condensation of vapors*

2 Safety information

The information in this chapter must be observed by everyone who works with the product described here.

The safety information is valid for the entire life cycle of the product.

2.1 Usage

Only use the product if it is in perfect working condition.

2.1.1 Intended use

Intended use A chemistry pumping unit of the *PC 3001 VARIO select* product series is a vacuum system consisting of a vacuum pump, controller, sensor and separator, for the creation and control of rough vacuum in designated systems, e. g. evacuating distillation instruments, in particular rotary evaporators.

Attached coolers (vapor condenser, immission condenser, dry ice cooler, emission condenser Peltronic®), including separators and flasks, are exclusively intended for the condensation of vapors.

The device may only be used indoors in a non-explosive atmosphere.

Intended use also includes:



- observing the information in the document **Safety information for vacuum equipment**,
- observing the manual,
- observing the manual of connected components,
- observing the inspection and maintenance intervals and having it performed by appropriately qualified personnel.
- using only approved accessories or spare parts.

Any other use is considered as improper use.

2.1.2 Improper use

Improper use Incorrect use or any application which does not correspond to the technical data may result in injury or damage to property.

Improper use includes:

- using the product contrary to its intended use,
- operation at improper environmental and operating conditions,
- operation despite obvious malfunctions or defective safety devices,
- unauthorized modifications or conversions, in particular when these impair safety,
- usage despite incomplete assembly,
- operation with sharp-edged objects,
- pulling plug-in connections on the cable out of the socket,
- to pump, to convey and to compress solids or fluids.

2.1.3 Foreseeable misuse

Foreseeable misuse In addition to improper use, there are types of use which are prohibited when handling the device:

Prohibited types of use are, in particular:



- use on humans or animals,
- installation and operation in potentially explosive atmospheres,
- use in mines or underground,
- using the device to generate pressure,
- fully exposing vacuum devices to the vacuum,
- immersing it in liquids, exposing it to water spray or steam jets,
- pumping oxidizing and pyrophoric substances, liquids or solids,
- pumping of hot, unstable, or explosive media,
- pumping substances which may react explosively under impact and/or elevated temperature without an air supply.

IMPORTANT!

The penetration of foreign objects, hot gases and flames from the application, must be excluded.

2.2 Obligations

2.2.1 Operator obligations

Operator obligations The owner defines the responsibilities and ensures that only trained personnel or specialists work at the vacuum system. This applies in particular to connection, assembly and maintenance work and troubleshooting.

Users in the areas of competence in the *Responsibility matrix* must possess the relevant qualifications for the activities listed. Work on electrical equipment in particular may be performed only by electricians.

2.2.2 Personnel obligations

Personnel obligations In the case of activities which require protective clothing, personal protective equipment as specified by the operator is to be worn. If the vacuum system is not in proper order, it must be secured against being accidentally switched back on.

- ⇒ Always be conscious of safety and work in a safe manner.
- ⇒ Observe instructions issued by the operator, and national regulations on accident prevention and industrial safety.



Personal behaviour may help to avoid work accidents.

2.3 Target group description

Target groups The manual must be read and observed by every person who is tasked with the activities described below.

Personnel qualification

Qualification description

Operators	Laboratory staff, such as chemists, laboratory technicians
Specialist	Person with professional qualification in mechanics, electrical equipment or laboratory devices
Responsible specialist	Similar to a specialist, with additional specialist responsibility, or responsibility for a department or division

Responsibility matrix

Responsibility Assignment Matrix

Activity	Operators	Specialist	Responsible specialist
Installation	x	x	x
Commissioning	x	x	x
Network integration			x
Operation	x	x	x
Error report	x	x	x
Remedy	x	x	x
Maintenance		x	x
Repair ¹		x	x
Repair order			x
Cleaning, simple	x	x	x
Empty separator flask	x	x	x
Shutdown	x	x	x
Decontamination ²		x	x

1 see also website:
 VACUUBRAND > Support > [Instructions for repair](#)

2 Alternatively, arrange for decontamination by a qualified service provider

2.4 Safety precautions, general

Quality standards
and safety

Products from **VACUUBRAND GMBH + CO KG** are subject to stringent quality testing with regard to safety and operation. Each product undergoes a comprehensive test program prior to delivery.

2.4.1 Protective clothing

Protective clothing

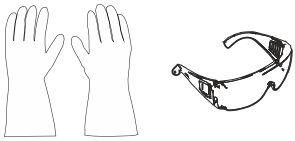

For operation no special protective clothing is required. Observe the owners' directives at work for your workplace.

During cleaning, maintenance and repair work, we recommend wearing full protective gloves, protective clothing and protective goggles.

IMPORTANT!

⇒ When handling chemicals, wear your personal protective equipment.

2.4.2 Safety precautions

Safety precautions

- ⇒ Use the vacuum device only if you have understood its function and this manual.
- ⇒ Replace defective parts immediately, e. g., a broken cable, faulty flask or faulty hose.
- ⇒ Use only original accessories and components which are designed for the vacuum technology, such as a vacuum hose, separator, vacuum valve, etc.
- ⇒ When handling contaminated parts, follow the relevant regulations and safety precautions, this also applies to equipment sent in for repair.

IMPORTANT!

Prior to any service, contamination from hazardous substances needs to be excluded.

⇒ Fill out the [Health and Safety Clearance form](#) in full and confirm with your signature.

2.4.3 Laboratory and working materials

	DANGER
	<p>Hazardous substances could emit at the outlet. During aspiration, hazardous, toxic substances at the outlet can get into ambient air.</p> <ul style="list-style-type: none"> ⇒ Observe the national regulations for safe handling of hazardous substances. ⇒ Please note that residual process media may pose a danger to people and the environment. ⇒ Mount and use suitable separators, filters or fume hood devices.

Risks due to various substances

Pumping different substances

Pumping different substances or media can cause the substances to react with one another.

Working substances which get into the vacuum pump with the gas flow can damage the vacuum pump. Hazardous substances can deposit in the vacuum pump.

Possible safety precautions, depending on the application:

- ⇒ Flush the vacuum pump with inert gas or air before changing the medium to be pumped.
- ⇒ Use inert gas to dilute critical mixtures.
- ⇒ Prevent the release of hazardous, toxic, explosive, corrosive fluids, gases or vapors or those that are harmful to health or the environment, for example, through suitable laboratory facilities with a fume hood and ventilation control.
- ⇒ Protect the inside of the vacuum pump from deposits or moisture, e. g, through the provision of a gas ballast.
- ⇒ Be aware of interactions and possible chemical reactions of the pumped media.
- ⇒ Check the compatibility of the pumped substances with the wetted materials of the pumping unit.
- ⇒ Contact us if you have concerns about using your vacuum pump with certain working materials or media.

2.4.4 Eliminate sources of danger

Take mechanical stability into account

Note mechanical
load capacity

Due to the high compression ratio of the pump, pressure can develop at the outlet which exceeds that which the mechanical stability of the system allows.

- ⇒ Always ensure that the exhaust gas line is clear and non-pressurized. To ensure unhindered emission of gases, the outlet should not be blocked.
- ⇒ Prevent uncontrolled overpressure, for example, due to a locked or blocked piping system, condensate or clogged exhaust gas line.
- ⇒ At the gas connections, the connections for the inlet *IN* and outlet *EX* should not be mixed up.
- ⇒ Be aware of the max. pressures at the inlet and outlet of the pump as well as the max. admissible differential pressure between the inlet and outlet, according to **8.1.1 Technical data on page 74**
- ⇒ The system to be evacuated as well as all hose connections must be mechanically stable.
- ⇒ Fix coolant hoses to the hose nozzles such that they cannot inadvertently become loose.

Prevent condensate reflow

Prevent backup in
the exhaust gas line

Condensate can damage the pump head. No condensate should flow back into the outlet *EX* and pump head due to the hose line. No liquid should accumulate inside the exhaust hose.

- ⇒ Avoid condensate return by using a separator. No condensate must enter the housing interior via the vacuum hoses.
- ⇒ Preferably lay the exhaust gas hose such that it descends from the outlet; that is, position it running downward so that no backup forms.

Avoid incorrect measurements

Incorrect measurement due to an obstructed vacuum line, e. g., condensate in the vacuum line can distort the measurements of the vacuum sensor.

⇒ Prevent overpressure > 1060 mbar (795 Torr) inside the suction line.

Avoid foreign bodies inside the pump

Observe vacuum pump dimensioning

Particles, liquids and dusts should not get inside the vacuum pump.

⇒ Do not pump any substances which could form deposits inside the vacuum pump.

⇒ Install suitable separators and/or filters in front of the inlet. Suitable filters are, e. g., chemically resistant, clog-proof and have a reliable flow rate.

⇒ Immediately replace porous vacuum hoses.

Risks during venting

Be aware of risks during venting

Depending on the application, venting can cause explosive mixtures to form or other hazardous situations to arise.

Risks due to residual energy

Possible residual energies

After the device has been switched off and disconnected from the power supply, there may still be dangers at the plug-in power supply due to residual energy:

■ Thermal energy: Motor waste heat, hot surface, compression heat.

⇒ Allow the vacuum pump to cool off.

■ Electrical energy: In capacitors on the electronics, they have a discharge time of up to 3 minutes.

⇒ Wait for at least 3 minutes until capacitors have discharged.

Risk of burns due to hot surface

Surface temperatures

The surface of the vacuum pump can reach operating temperatures higher than **> 70 °C**, in particular when pumping heated media.

- ⇒ Avoid direct contact with the surface.
- ⇒ Use protection against accidental contact if the surface temperature is regularly elevated.
- ⇒ Allow the vacuum pump to cool off before performing maintenance work.

Overheating

The vacuum pump can be damaged due to overheating. Possible causes include insufficient air supply to the fan and failure to maintain minimum distances.

- ⇒ When installing the device, ensure that there is a minimum distance of 5 cm between the cooling fan and adjacent parts (such as the housing, walls, etc.).
- ⇒ Always ensure sufficient air supply; if applicable, provide external forced ventilation.
- ⇒ Place the device on a stable surface; a soft surface such as foam rubber as a sound absorber can impair and block the air supply.
- ⇒ Clean polluted ventilation slots.
- ⇒ Remove covers from the device before operating it.
- ⇒ Avoid excessive heat input due to hot process gases.
- ⇒ Observe the maximum admissible media temperature
→ *see chapter: 8.1.1 Technical data on page 74.*

Handling coolants and cryogenic materials

Risks when handling with cryogenic substances

Cryogenic materials can cause frostbite (cold burns) upon contact with skin.

- ⇒ Observe the valid regulations for handling cryogenic substances.
- ⇒ Use only approved transport containers.
- ⇒ Take the necessary safety precautions when handling cryogenic media, such as dry ice.
- ⇒ Never use damaged components.
- ⇒ Wear your personal protective equipment when handling hazardous materials.
- ⇒ Ensure ventilation of the workplace.

Dry ice should not be used in gas-tight containers. Do not fix the cover on top of the dry ice condenser. Pressure equalization between the coolant and the atmosphere must be ensured at all times.

Keep signs legible

Warning signs and labels

Keep labels and information symbols and warning labels always in a well readable condition:

- ⇒ Connection labeling
- ⇒ Warning signs and notice labels
- ⇒ Motor data and rating plates

2.5 Motor protection

Overheating protection, blockage protection

The pump motor has a temperature sensor on the circuit board as overload protection. In the event of excessive temperature or if the motor is blocked, the vacuum pump switches off.

Procedure for switching vacuum pump back on

If the vacuum pump is switched off due to these safety precautions, the fault must be manually reset: Unplug pumping unit from power supply -> eliminate cause of error -> switch pumping unit back on.

2.6 ATEX equipment category

Installation and potentially explosive atmospheres



The installation and operation in areas where potentially explosive atmospheres can develop to a hazardous degree is not permitted.

ATEX approval only applies to the internal, wetted parts of the of the product, not to its surroundings.

ATEX equipment labeling

ATEX
equipment category



Vacuum equipment labeled with Ex has ATEX approval in line with the ATEX marking on the rating plate.

- ⇒ Only use the product if it is in perfect working condition.
- ⇒ The devices are designed for a low level of mechanical stress and must be installed in such a way that they cannot sustain mechanical damage from the outside.

ATEX
equipment category
and peripherals

The ATEX category of the product is dependent on the connected peripheral devices. Components and connected peripherals need to have the same or higher ATEX approval.

Prevent
ignition source

The use of gas ballast and/or venting valves is only permitted if this would not normally, or only rarely, cause explosive mixtures within the device, or do so only for a short time.

- ⇒ If necessary vent with inert gas.

Information on the ATEX equipment category is also available on our website at: www.vacuubrand.com/.../Information-ATEX

2.7 Proper disposal

NOTICE

Risk of environmental damage due to incorrect disposal of the product.

- ⇒ Do not dispose your product in household waste!
Electronic components are subject to hazardous waste treatment and must only be disposed of by certified specialists.
- ⇒ Observe the national regulations for safe disposal and environmental protection.
- ⇒ Detailed information on the respective regulations can be obtained from your local administrative authority.



3 Product description

Pumping units of the PC 3001 VARIO select series generally consist in each case of a diaphragm pump with VARIO® drive, a VACUU·SELECT® vacuum controller as well as a cooler with separator. Condensers are available in various designs. The differences concern the functioning of the cooler.

3.1 PC 3001 VARIO select (basic design)

Side and front view, basic model

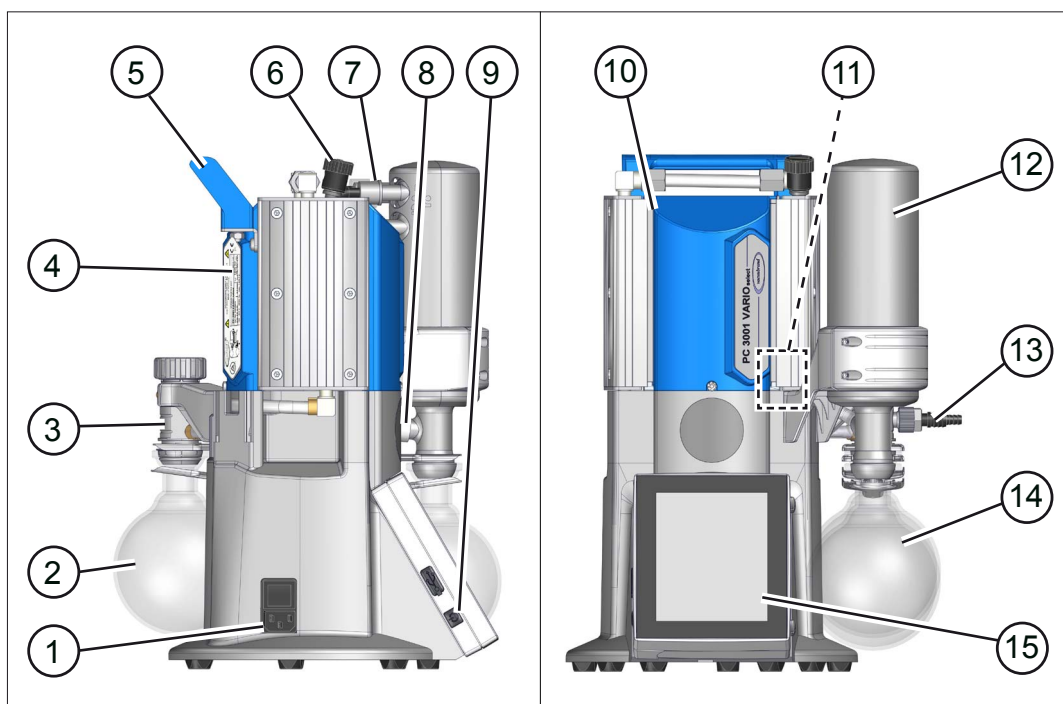

Meaning

- | | |
|----|---|
| 1 | Power connection with on/off switch (rocker switch) |
| 2 | Separator flask, round bottom flask at the inlet |
| 3 | Distribution head |
| 4 | Rating plate |
| 5 | Handle |
| 6 | Gas ballast valve |
| 7 | Connections at the EK: Outlet, coolant |
| 8 | Overpressure relief valve |
| 9 | ON/OFF button vacuum controller |
| 10 | Chemistry diaphragm pump |
| 11 | VACUU·SELECT® Sensor, mounted inside the pumping unit |
| 12 | Vapor condenser EK |
| 13 | Vacuum inlet, on the rear round bottom flask |
| 14 | Round bottom flask at the outlet |
| 15 | VACUU·SELECT® operating panel, removable |

3.2 Chemistry pumping units

Overview of the PC 3001 VARIO select Series

Overview
Chemistry pumping
units

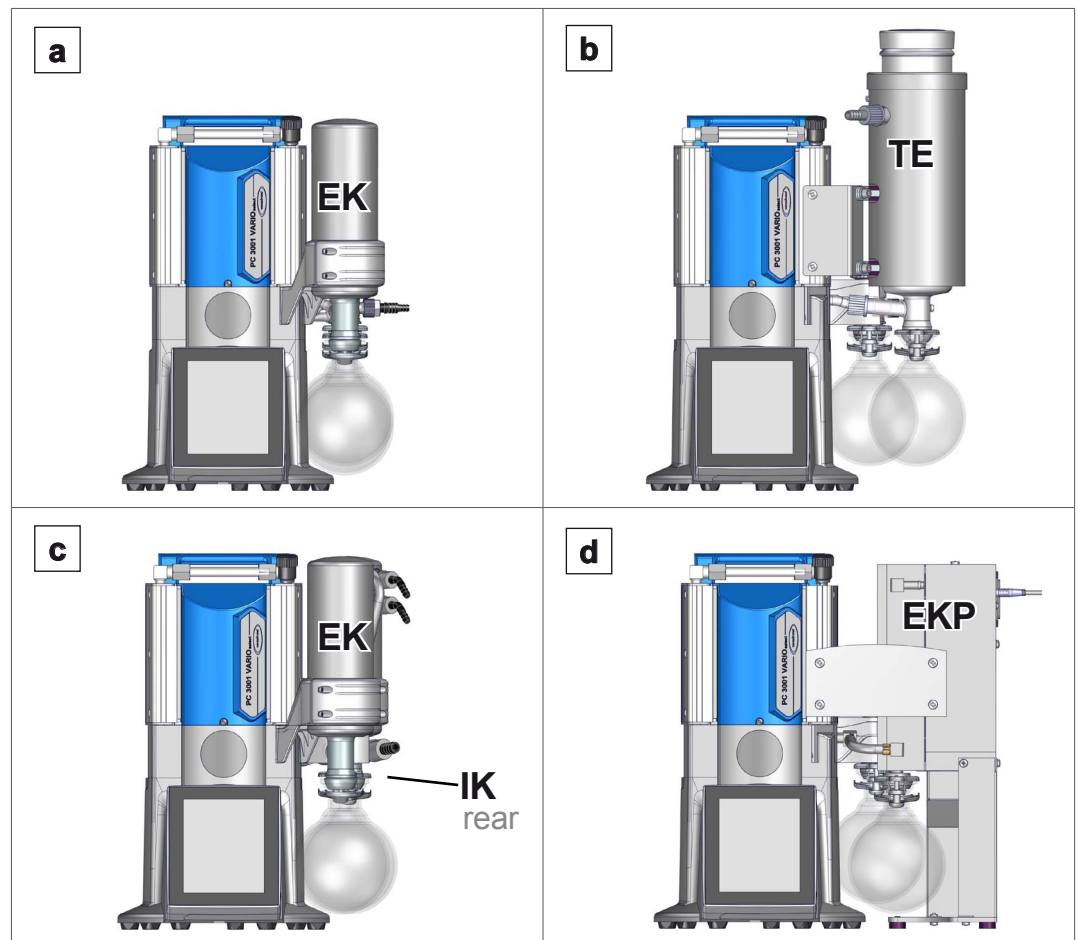

Meaning

Chemistry pumping unit	AK	IK	EK	EKP
a PC 3001 VARIO select	●		●	
b PC 3001 VARIO select TE	●		●	
c PC 3001 VARIO select IK		●	●	
d PC 3001 VARIO select EKP	●			●

Product-specific abbreviations

Product-specific
abbreviations

- AK** Separator flask
- EK** Vapor condenser, mounted at the outlet
- EKP** Peltronic® emission condenser, mounted at the outlet
- IK** Immission condenser, mounted at the inlet
- o. EK** without vapor condenser
- PC** Chemistry pumping unit with type identification number
- TE** Dry ice condenser, dry ice cooler

3.3 Condensers and coolers

3.3.1 Separator / Condenser at the inlet

Connection to separator flask

Connections at the AK

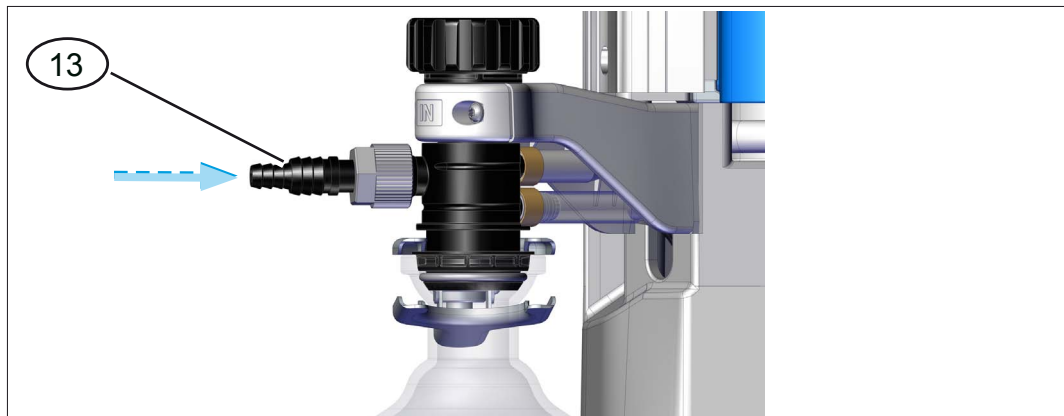

Meaning

13 Inlet connection vacuum IN

Connection and coolant at the immission condenser

Connections at the IK

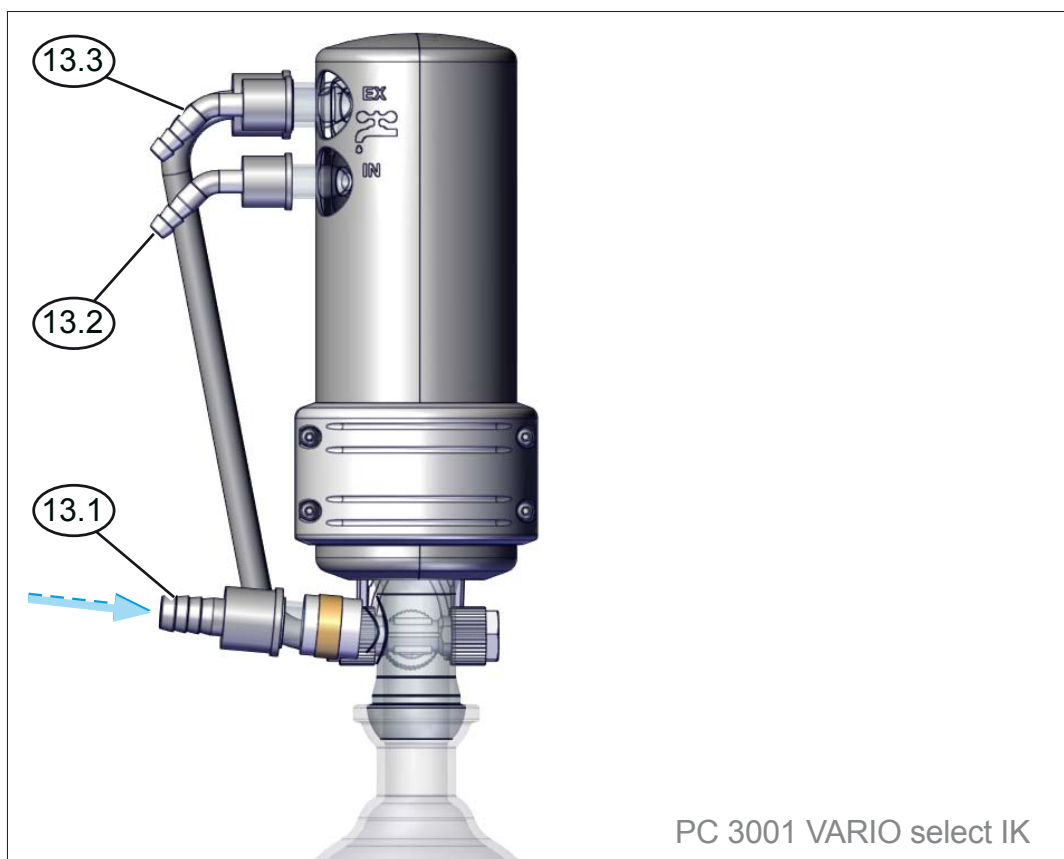

Meaning

- 13.1** Inlet connection vacuum IN
- 13.2** Inlet connection coolant IN, e. g, water
- 13.3** Outlet connection coolant EX

3.3.2 Condenser at the outlet

Connection and coolant at vapor condenser

Connections at the EK



Meaning

7.1	Exhaust gas connection EX
7.2	Outlet connection coolant EX
7.3	Inlet connection coolant IN, e. g, water

Connection and coolant at dry ice condenser

Connections at TE
PC 3001 VARIO
select TE

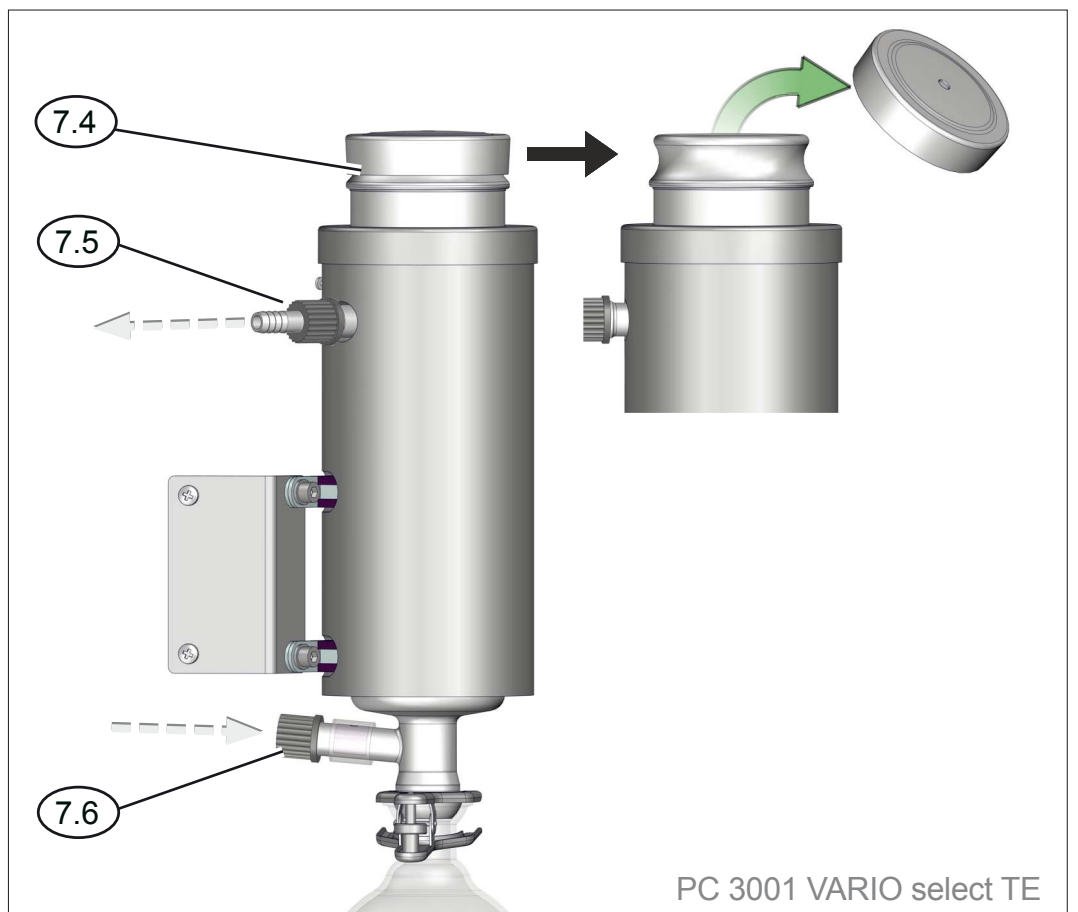

PC 3001 VARIO select TE

Meaning

7.4	Opening for freezing mixture, e. g. dry ice mixture Coolant insert can be removed for emptying, secured by bayonet coupling
7.5	Exhaust gas connection EX
7.6	Connection from vacuum pump

Connections on the Peltronic® emission condenser

Connections at the EKP

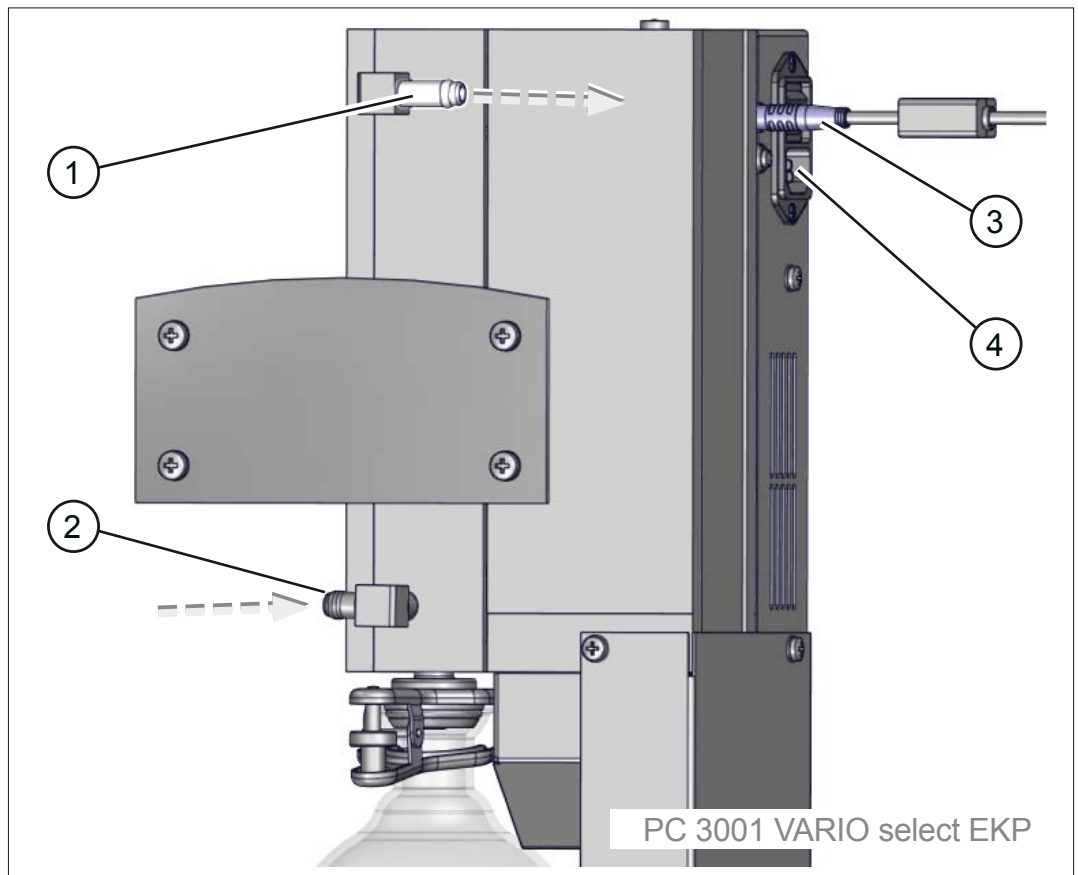

Meaning

- | | |
|---|--|
| 1 | Exhaust gas connection EX |
| 2 | Vacuum pump connection |
| 3 | VACUU·BUS® connection |
| 4 | To switch the gauge on/off with tools, |

For detailed information on and descriptions of the Peltronic® → emission condenser, *see manual #20901074.*

3.4 Examples of use

Evaporation

→ Example
Rotary evaporation

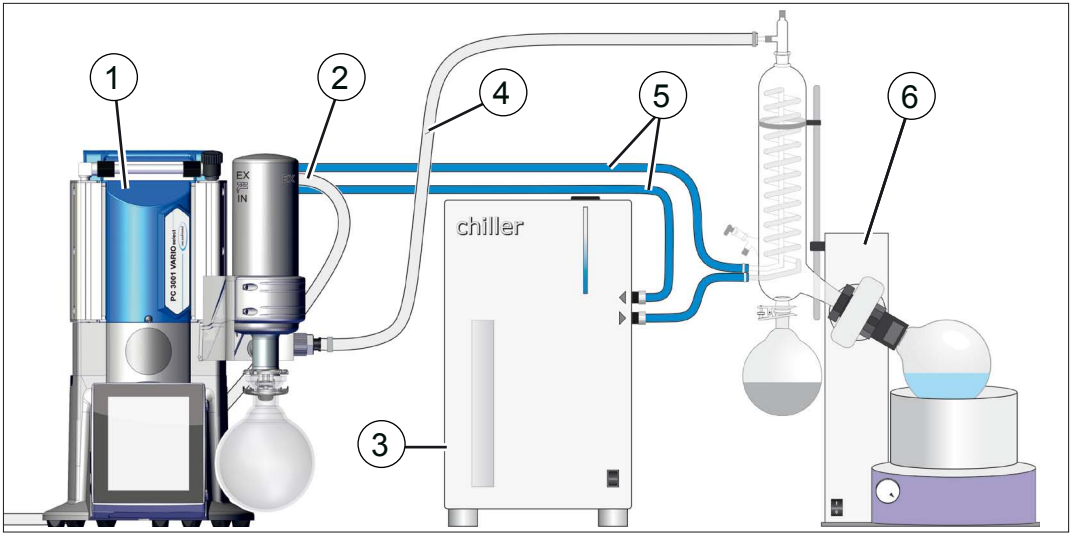

Meaning

1	Vacuum pumping unit PC 3001 VARIO select
2	Exhaust gas hose (laid into a fume hood)
3	Chiller
4	Vacuum hose
5	Coolant hoses (connected in series)
6	Example of use: Rotary evaporator

Vacuum concentrator

→ Example
Vacuum concentrator

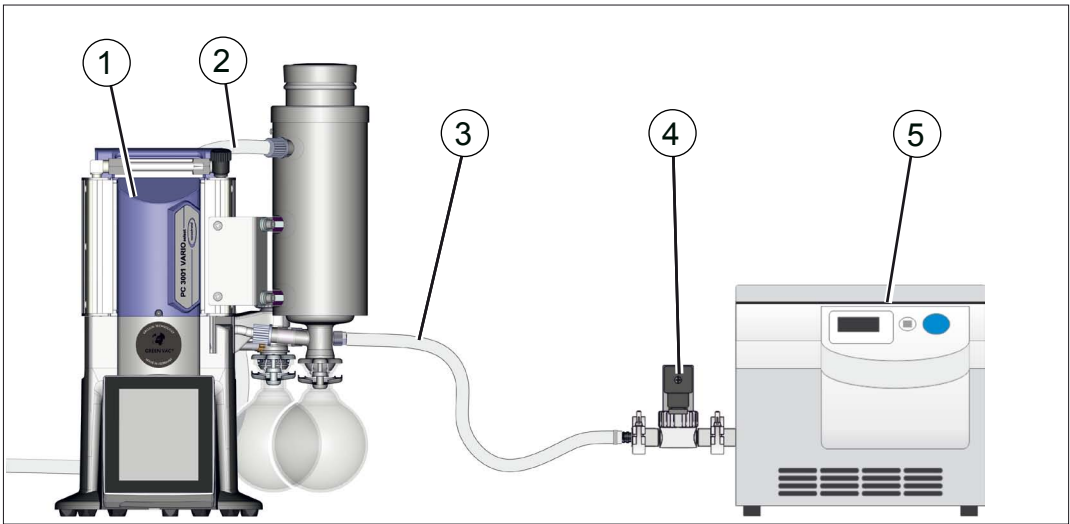

Meaning

1	Vacuum pumping unit PC 3001 VARIO select TE
2	Exhaust gas hose (laid into a fume hood)
3	Vacuum hose
4	Vacuum valve: Shut-off valve
5	Examples of use: Vacuum concentrator

4 Installation and connection

4.1 Transport

Products from **VACUUBRAND** are packed in sturdy, recyclable packaging.



The original packaging is accurately matched to your product for safe transport.

- ⇒ If possible, please keep the original packaging, e. g., for returning the product for repair.

Goods arrival

Check the shipment for transport damage and completeness.

- ⇒ Immediately report any transport damage in writing to the supplier.

Unpacking

→ Example
Pumping unit in
original packaging

Glass flask in
enclosed box

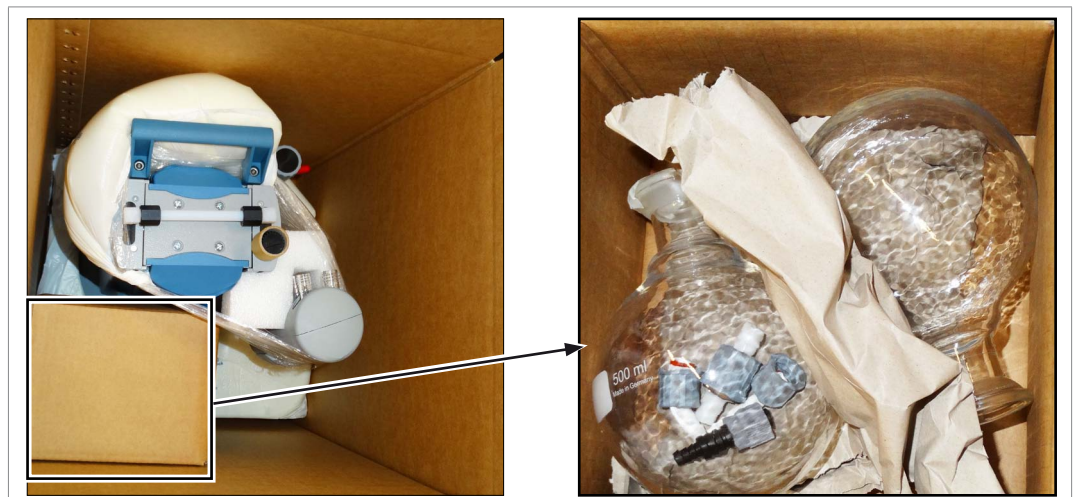

- ⇒ Lift the device only using the intended carrying handles or recessed grips.
- ⇒ Remove the connections, such as hose nozzles and screw connections, out from the glass flask.
- ⇒ Compare the scope of delivery with the delivery note.

4.2 Installation

NOTICE

Condensate can damage the electronics.

A large temperature difference between the storage location and the installation location can cause condensation.

⇒ After goods receipt or storage, allow your vacuum device to acclimatize for at least 3-4 hours before initial use.

Check installation conditions

Check installation conditions

- The device is acclimatized.
- Ambient conditions have been observed and are within the limitation of use.
- The pump must have a stable and secure base without additional mechanical contact apart from the pump feet.

Installing the vacuum pump

⇒ Place the vacuum pump on a stable, nonvibrating, level, horizontal surface.

→ Example Sketch
Minimum distances in laboratory furniture

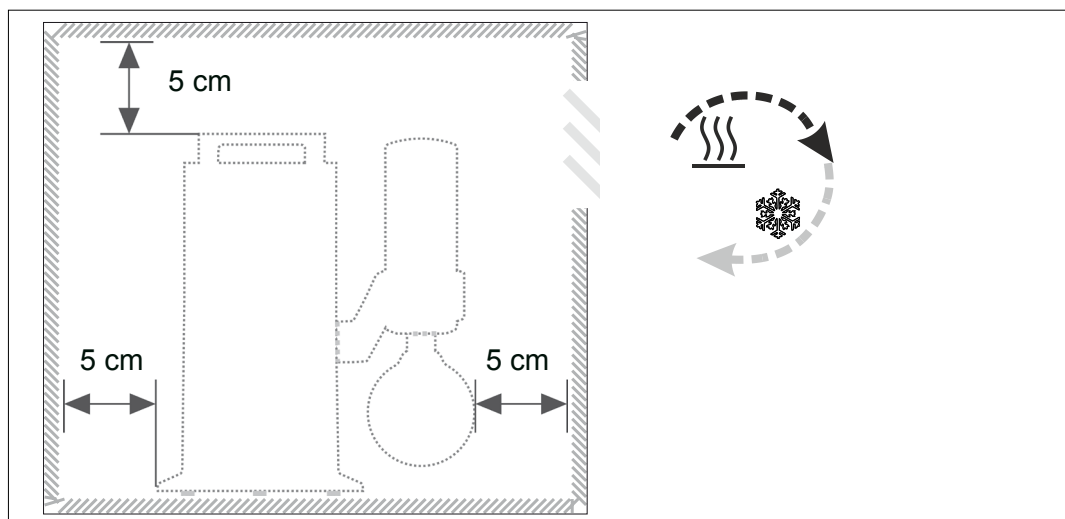

IMPORTANT!

- ⇒ When installing in laboratory furnishings, maintain a minimum distance of 5 cm (2 in.) from adjacent objects or surfaces.
- ⇒ Prevent heat accumulation and ensure sufficient air circulation, especially in closed housings.

Observe limitations of use

Observe limitation of use

Limitation of use		(US)
Ambient temperature	10–40 °C	50–104°F
Altitude, max.	2000 m NHN	6562 ft above sea level
Minimum distance to adjacent parts	5 cm	2 in
Coolant circuit, max. pressure	3 bar	44 psi
Relative humidity	30–85 %, non condensing	
Protection type	IP 20/IK 08	
Prevent condensation or contamination from dust, liquids, or corrosive gases.		

IMPORTANT!

- ⇒ Note the IP protection class of the controller. IP protection is only guaranteed if the device is appropriately installed and correctly connected.
- ⇒ For connection also note rating plate data and chapter *8.1.1 Technical data on page 74.*

4.3 Connection

All condensers of the pumping unit series have a vacuum connection and an exhaust gas connection. The connection is very similar. Perform the connection for your pumping unit as described in the examples below.

4.3.1 Vacuum connection (IN)

	CAUTION
	<p>Flexible vacuum hoses can contract during evacuation.</p> <p>Unsecured connected components can cause injuries or damage due to jerky movement (shrinkage) of the flexible vacuum hose. The vacuum hose can come loose.</p> <ul style="list-style-type: none"> ⇒ Fix the vacuum hose to the connections. ⇒ Fix connected components. ⇒ Measure the flexible vacuum hose such that you take the maximum shrinkage into account.

NOTICE

Foreign bodies in the suction line can damage the vacuum pump.

⇒ Prevent particles, liquids or contaminants from being aspirated or being able to flow back.

Connect vacuum hose

Vacuum connection
at the inlet IN

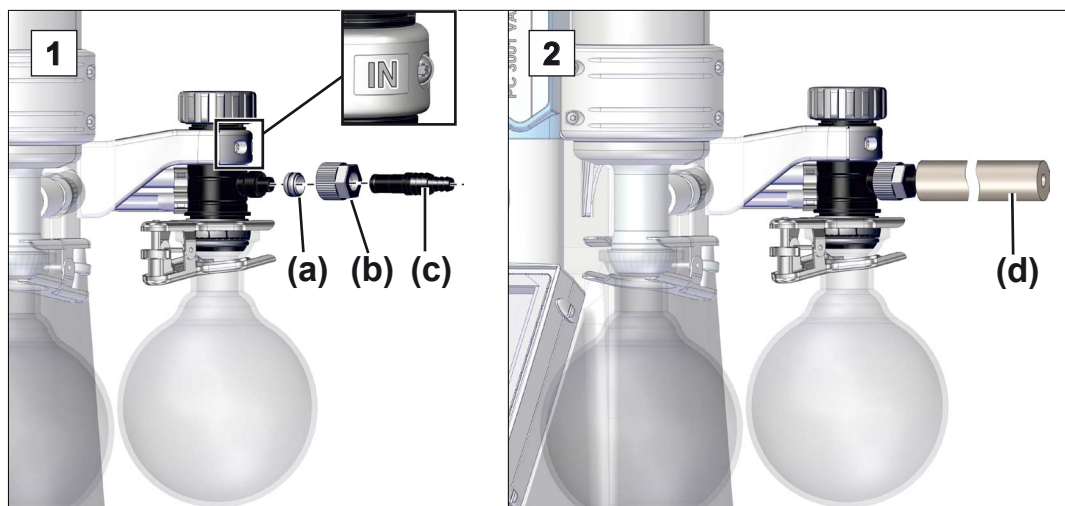

1. Connect the sealing ring **(a)**, knurled nut **(b)** and hose nozzle **(c)** as shown.
2. Push the vacuum hose **(d)** from the apparatus onto the hose nozzle and secure the vacuum hose, for example, with a hose clamp.

IMPORTANT!

- ⇒ Use the vacuum hose which is designed for the vacuum range used and which has sufficient stability.
- ⇒ Connect hose lines as short as possible.
- ⇒ Connect hose lines in a gas-tight manner to the vacuum pump.



Please observe the following points to get an optimal result:

- ⇒ Connect a vacuum line as short as possible with a cross-section as wide as possible.

4.3.2 Exhaust gas connection (EX)

	WARNING
	<p>Risk of bursting due to overpressure inside the exhaust tube.</p> <p>Inadmissibly high pressure in the exhaust gas line can cause the vacuum pump to burst or damage seals.</p> <ul style="list-style-type: none"> ⇒ The exhaust gas line (outlet, gas outlet) must always be clear and non-pressurized. ⇒ Always position the exhaust gas hose downwards or take measures to prevent condensate from flowing back into the vacuum pump. ⇒ Observe the maximum admissible pressures and pressure differences.

Connect exhaust gas hose

→ Example
Exhaust gas connection at the outlet EX

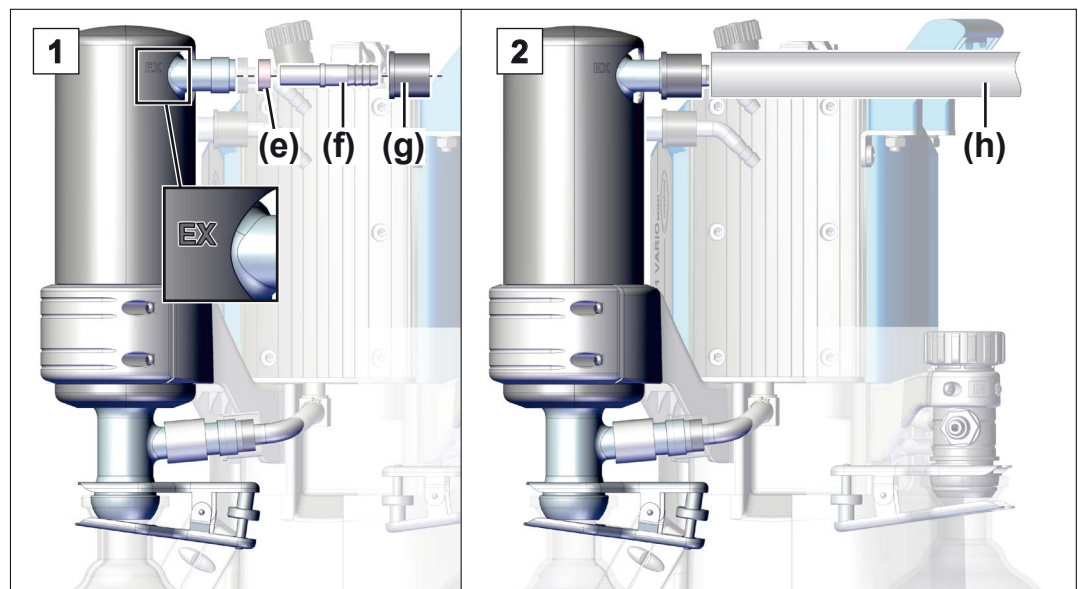

1. Connect the sealing ring (e), the hose nozzle (f) and the knurled nut (g) as shown and screw this onto the connection.
2. Push the exhaust gas hose (h) onto the hose nozzle and lay the hose, if necessary, in a fume hood. If necessary fix the vacuum hose, e. g., with a hose clamp.

4.3.3 Coolant connection at the condenser

Coolant connection
 IN = Feed line
 EX = outlet

Both an emission condenser EK and an immission condenser IK have a connection for coolant liquids. Water or the liquid from, e. g., a chiller are suitable for cooling.

IMPORTANT!

In a closed, in-house cooling water circuit, the pressure should be limited to 3 bar (44 psi).

A cooling water valve may only be installed in the intake; the coolant drainage must be clear and non-pressurized.

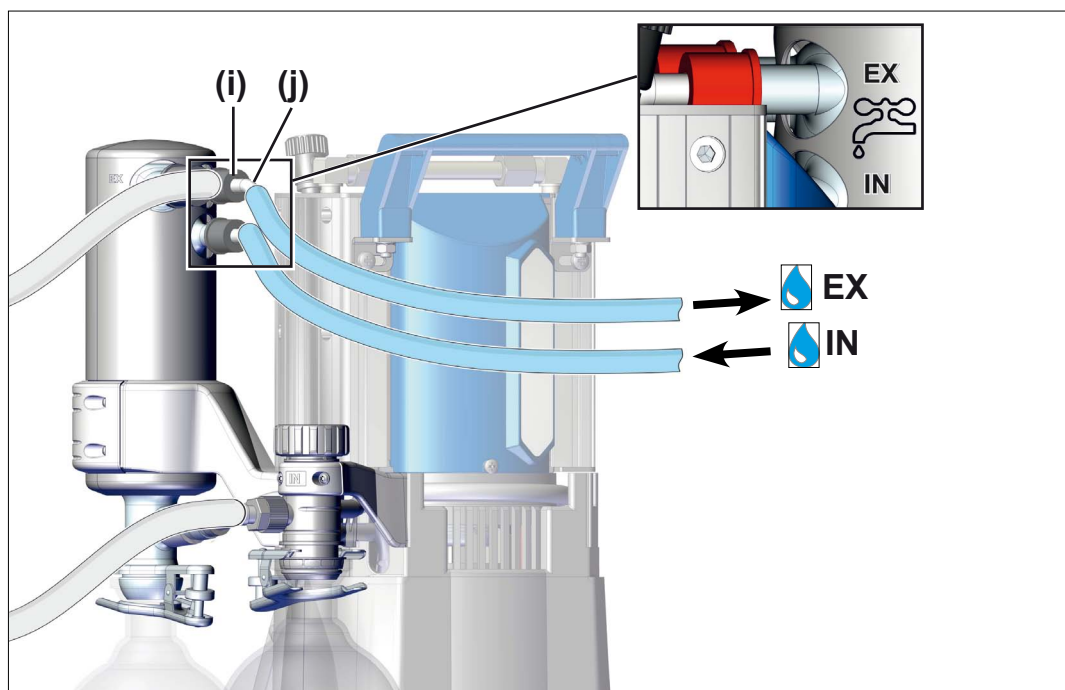

Connect coolant

→ Example
 Coolant connection
 at the EK or IK



1. Fix both hose nozzles (i) to the condenser as shown using the knurled nut (j).
2. Fix the hoses for the coolant on the condenser as shown. IN = inlet, e. g., from rotary evaporator, EX = outlet, e. g., to chiller.
3. Fix the vacuum hoses, e. g., with hose clamps.

4.3.4 Dry ice condenser

	CAUTION
	Risk of injury when handling cryogenic coolants.
	Cryogenic materials can cause frostbite, also known as cold burns, upon contact with skin.
	⇒ Avoid skin contact and always wear your personal protective equipment when handling cryogenic substances, e. g., protective gloves against thermal risk, protective goggles
	

NOTICE
Damage to the dry ice condenser due to cryogenic materials.
⇒ Always perform a visual inspection before each use,. The surfaces of the glass must be free of damage, ruptures, cracks or scratches.
⇒ Only place the lid on the dry ice condenser and ensure pressure equalization between the coolant and the atmosphere.
⇒ The coolant may unexpectedly escape from the cooler, e. g., in the event of a significant volume of gas.

Cooling with dry ice condenser

The dry ice condenser has no coolant connection. The dry ice cooler is filled with a freezing mixture for cooling. These freezing mixtures consist of cold to cryogenic media and a liquid for better transfer of cold.

Information coolant mixtures

Coolant mixtures (examples)		
Ethanol-dry ice mixture		
Water-ice mixture		
Saltwater-ice mixture		
Permissible chill temperatures		(US)
cold	-5 – -18 °C	23 – -0.4 °F
very chilly	-18 – -30 °C	0.4 – -22 °F
cryogenic	below -30 °C	less than -22 °F
lowest	-80 °C	-.112 °F

Fill dry ice condenser

→ Example
Fill dry ice
condenser with
freezing mixture

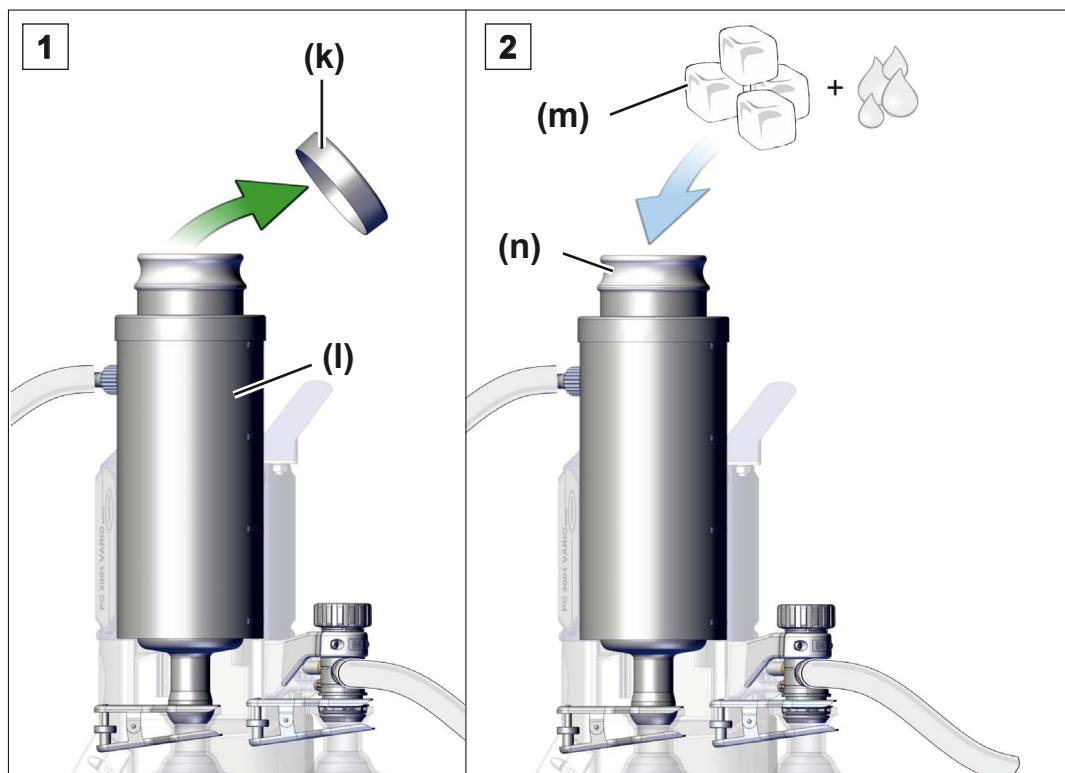

1. Take the lid **(k)** off of the dry ice condenser **(l)**.
2. Fill your preferred freezing mixture **(m)** into the container **(n)**.
3. Then place the lid back on the dry ice condenser.

IMPORTANT!

- ⇒ Do not overfill the container.
- ⇒ Always place the lid on; do not fix it.
- ⇒ Regularly check the coolant level in the cooler during operation.

Empty dry ice condenser TE

Before refilling the dry ice condenser with coolant, it may have to be emptied first. Remove and empty cooler insert (bayonet coupling).

Cooler insert
(bayonet coupling)

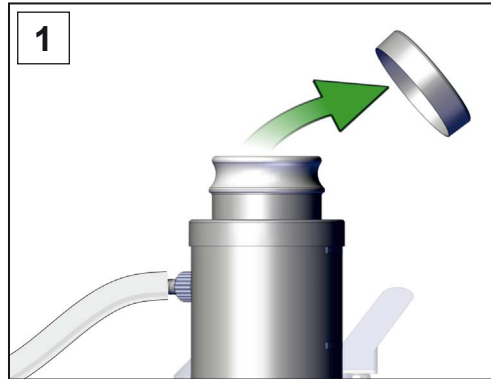

1. Take the lid off of the cooler.

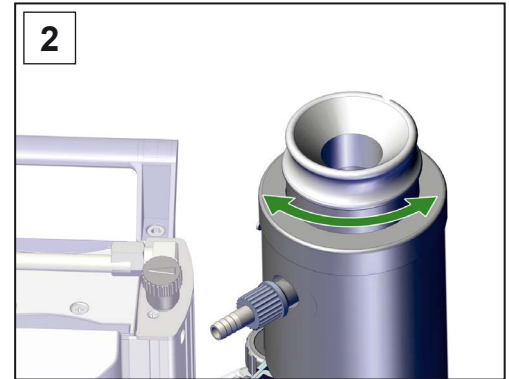

2. Turn the coolant insert – bayonet lock.



3. Pull out the container.

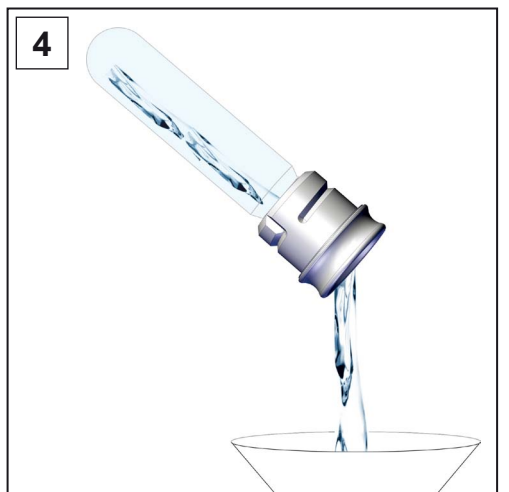

4. Drain the liquid.

5. Put the empty container back into the dry ice condenser in reverse sequence.

4.3.5 Venting connection



DANGER

Risk of explosion due to venting with air.

Depending on the application, venting can cause explosive mixtures to form or other hazardous situations to arise.

- ⇒ Never vent processes with air which could form an explosive mixture.
- ⇒ In the case of flammable substances, use only inert gas for venting, e. g., nitrogen (max. 1.2 bar/900 Torr abs.).

Venting with ambient air¹

Position of sensor
+ venting valve
cutaway sketch

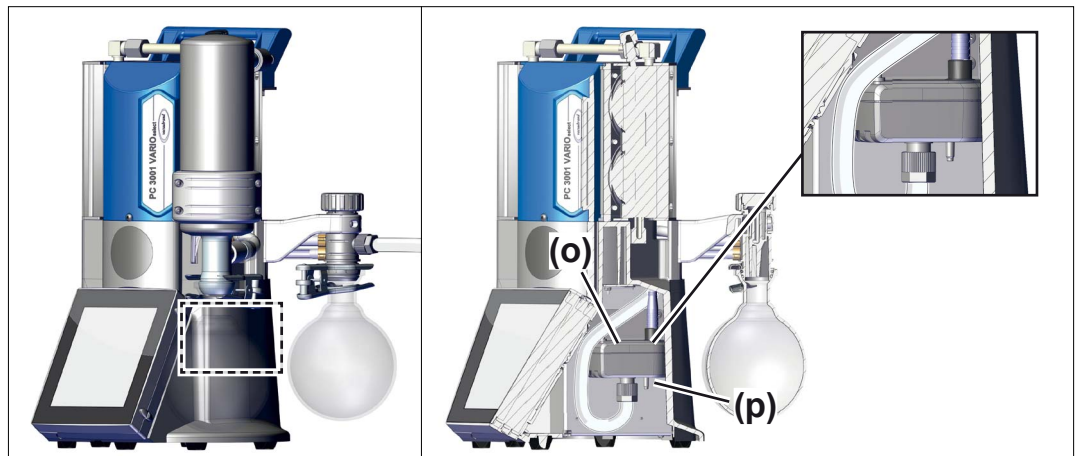

For venting **(p)** with ambient air, nothing needs to be connected to the sensor **(o)**.

¹ Only valid for sensors with integrated venting valve.

Venting with inert gas – connect venting valve²

Required connection material: Hose for hose nozzle (Ø 4–5 mm), e. g., silicone hose 3/6 mm.

Position of sensor
+ venting valve
connection cutaway
drawing

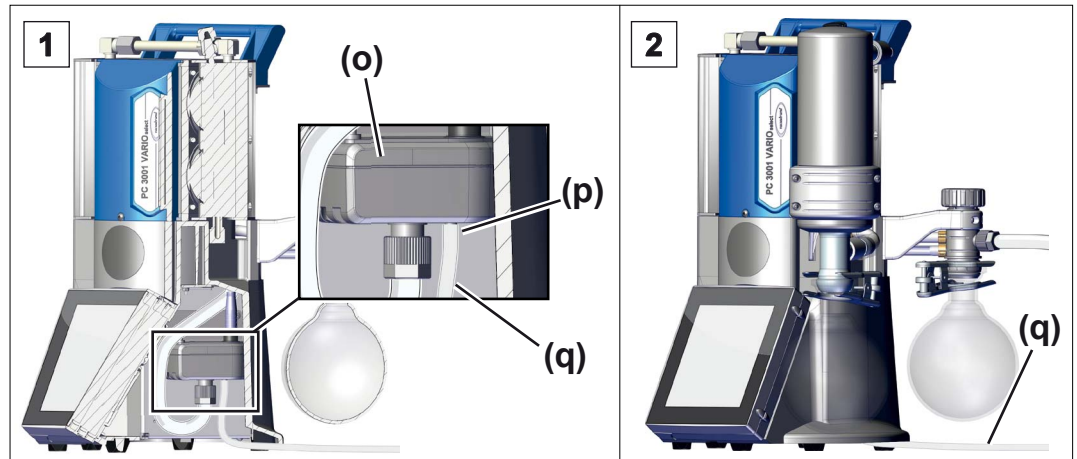

1. Tilt the pumping unit slightly to the side and attach the hose (q) to the connection of the venting valve (p) at the sensor (o).
2. Lay the hose under the pumping unit outwards and connect the inert gas (max. 1.2 bar/ 900 Torr, abs.).

² Avoid overpressure.

4.3.6 Gas ballast (GB)

Use ambient air as gas ballast

Position of gas ballast valve

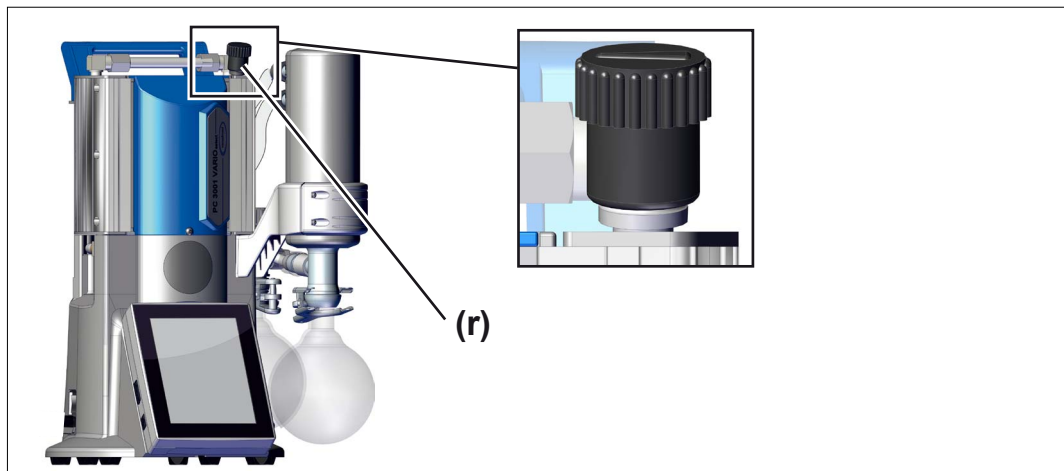

If ambient air is to be used as gas ballast, nothing must be connected at the pumping unit; gas ballast valve (r) → see also chapter 5.2.2 Operation with gas ballast on page 47

Use inert gas as gas ballast – OPTION

Prepare inert gas connection (GB)

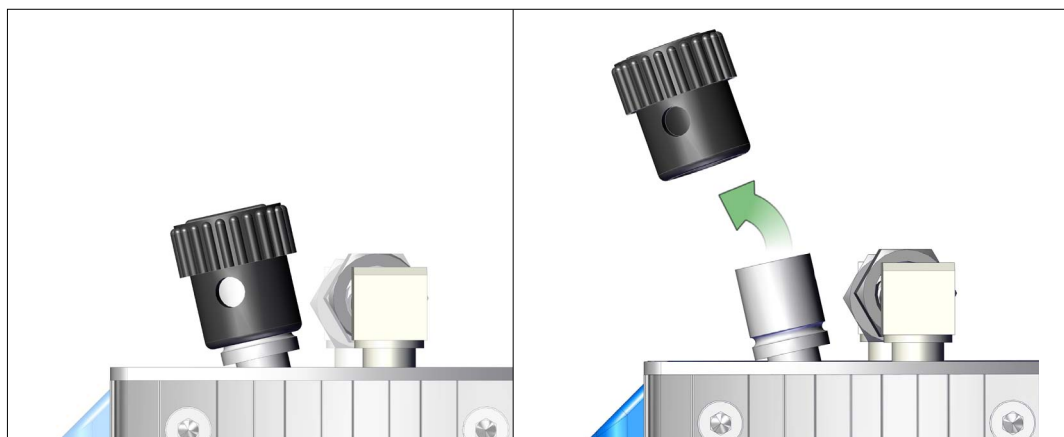

⇒ Remove the black gas ballast cap and connect a gas ballast adapter in its place.



You will receive connection options and adapters for hose nozzles or a small flange from us upon request.

4.3.7 Electrical connection

Connect pumping unit electrically

→ Example
Electrical connection
pumping unit

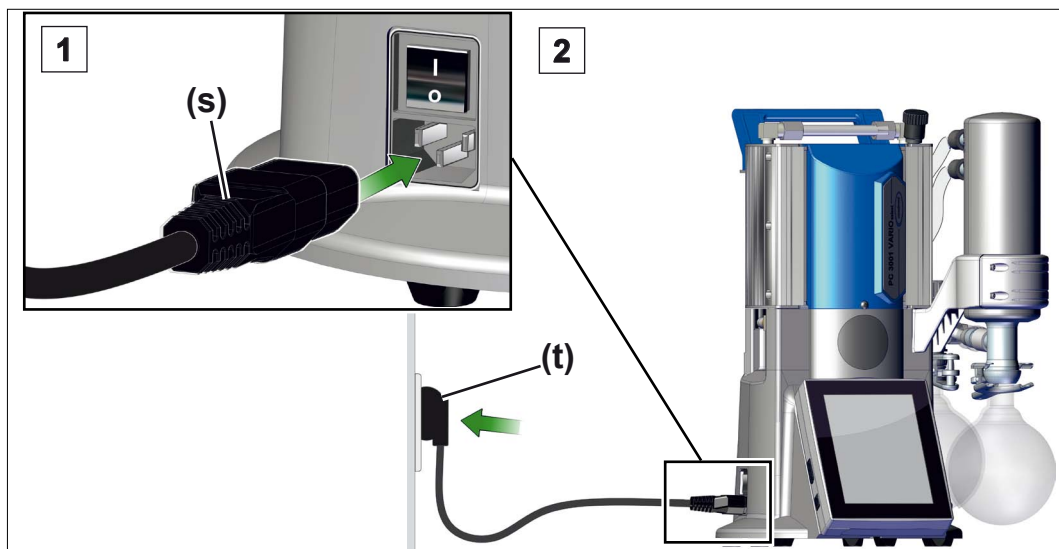

1. Insert the connector **(s)** of the power cable in the power connection of the vacuum pump.
2. Plug the wall power supply **(t)** into the mains socket.
 - Pumping unit connected electrically.

IMPORTANT!

⇒ Lay the connection cable such that it cannot be damaged by sharp edges, chemicals, or hot surfaces.

Mains (power) connections with country code

Diagrams of
standard power
connections with
grounding contact

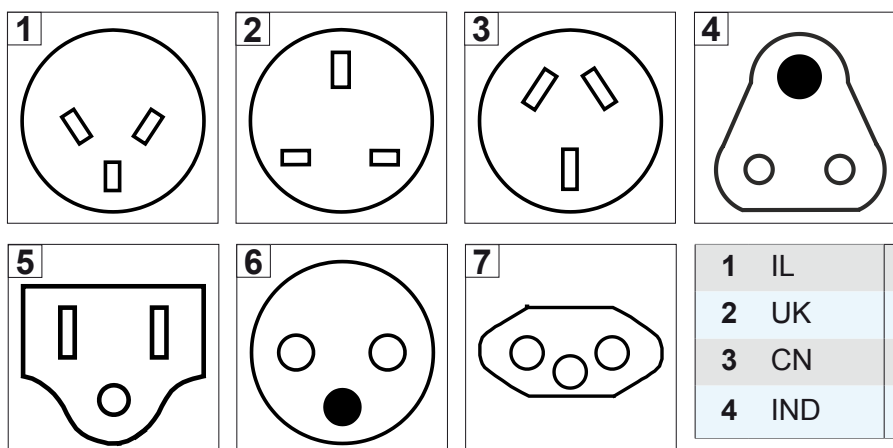

1	IL	5	US
2	UK	6	CEE
3	CN	7	CH
4	IND		

The vacuum pump is delivered with the appropriate power plug, ready for use.

IMPORTANT!

- ⇒ Use the power plug which fits your power supply.
 - ⇒ Do not use multi-outlet power strips connected in series as the power connection.
-

5 Initial use (operation)

5.1 Switch on

Switch on pumping unit

Switch on pumping unit

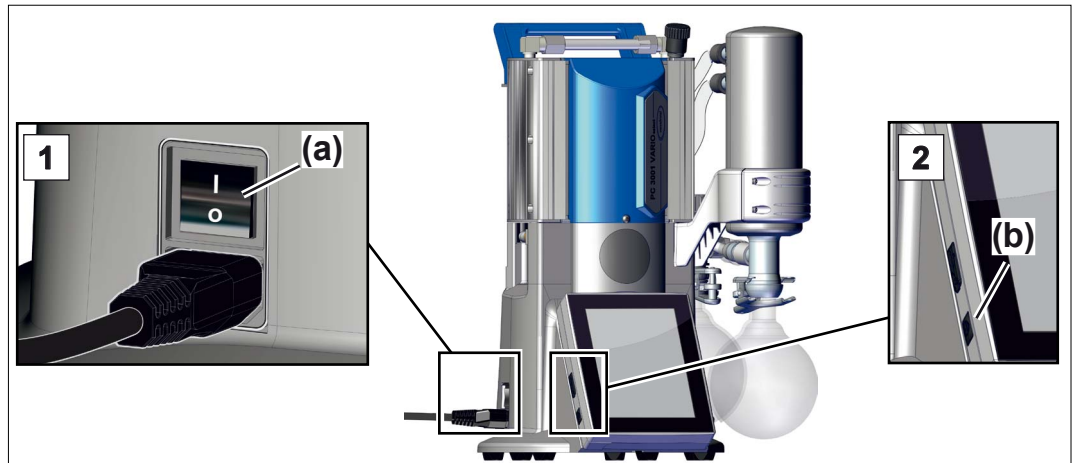

1. Switch the rocker switch (a) on – switch position I.
2. Press ON/OFF button (b) at the controller.
 - Display with start screen.
 - After approx. 30 seconds, the process screen appears with the operating elements in the controller display.

5.2 Operation

Operation by vacuum controller

This manual contains – apart from the chapters Switching on and Switching off – the mechanical description of the pumping unit of the **PC 3001 VARIO select** series.

The operation of the installed vacuum controller and its functions are described in its own manual **VACUU-SELECT**.

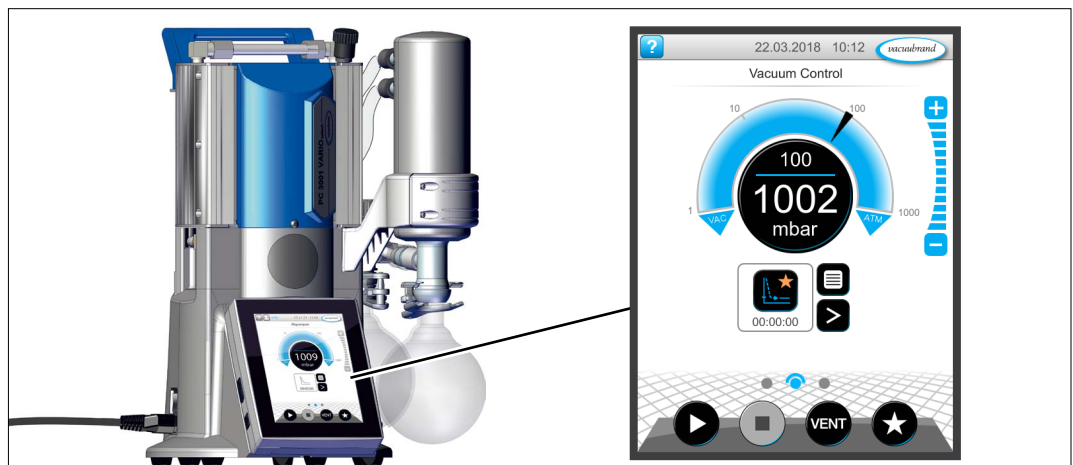

Process screen



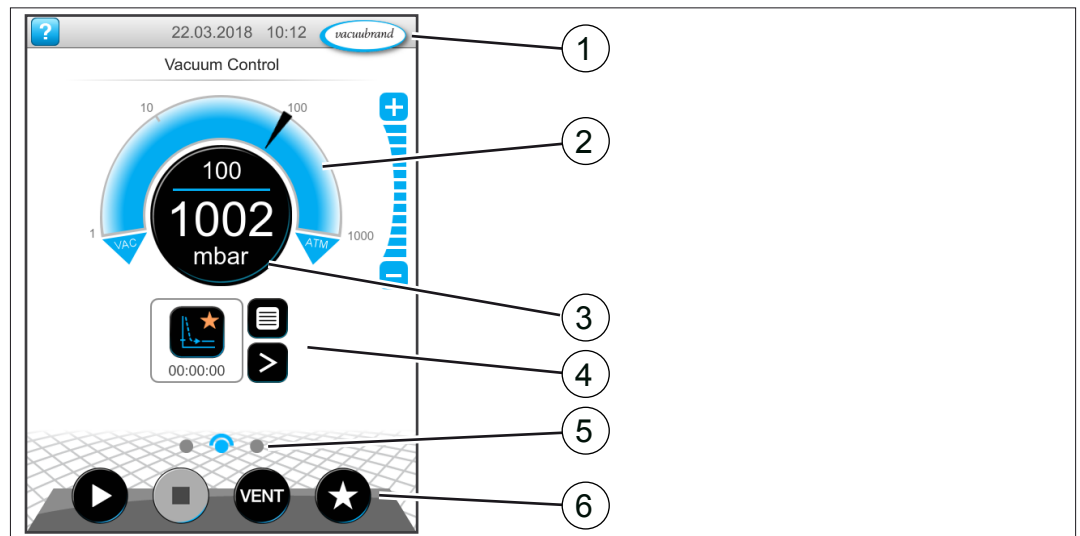





Process screen vacuum controller



- 1 Status bar
- 2 Analogue pressure reading – pressure curve
- 3 Digital pressure reading – pressure value (target value, actual value, pressure unit)
- 4 Process screen with context functions
- 5 Screen navigation
- 6 Operating elements for control

Operating elements

Operating elements vacuum controller

Button		Function
active	locked	
		Start ▶ Start application – only available on the process screen.
		Stop ▶ Stop application – always possible.
		VENT – vent the system (option) ▶ Press button < 2 sec = momentarily vent; control continues.
		▶ Press button > 2 sec = vent to atmospheric pressure; vacuum pump is stopped.
		▶ Press button during venting = venting is stopped.
		Favorites ▶ View Favorites menu.

* Button is only displayed if venting valve is connected or activated.

5.2.1 Operation (→ see description of controller)

Start the vacuum controller

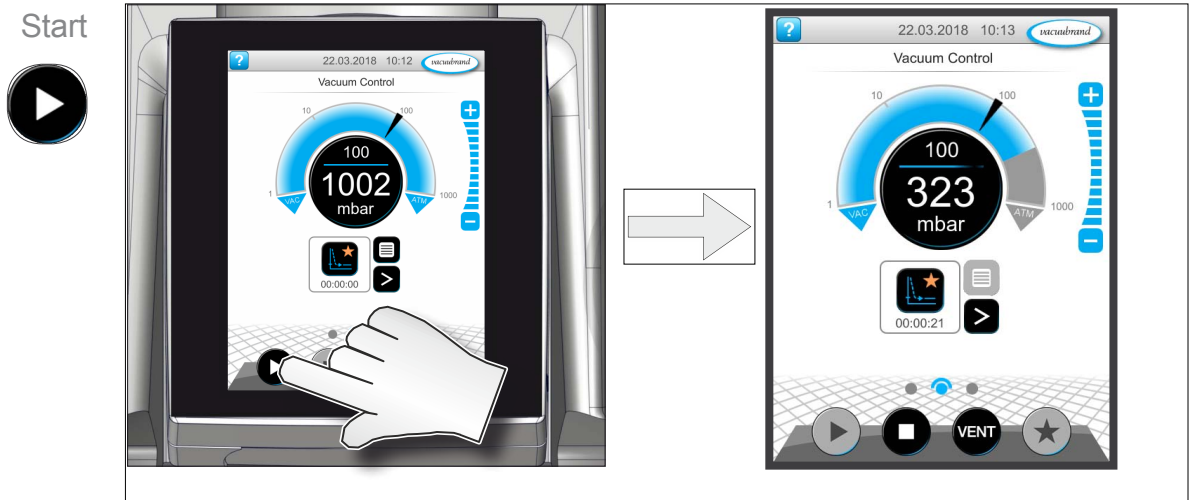

Stop the vacuum controller

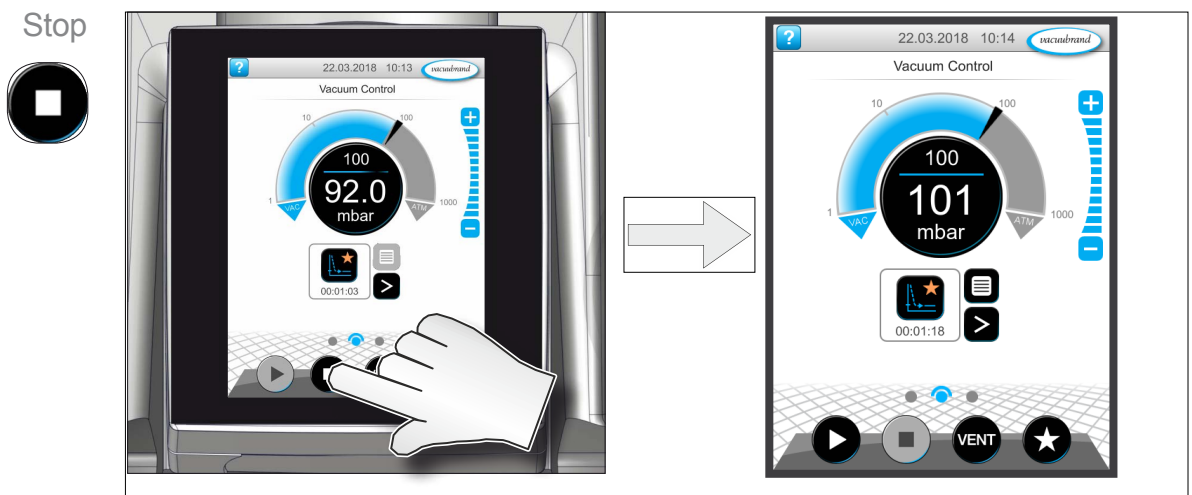

Venting

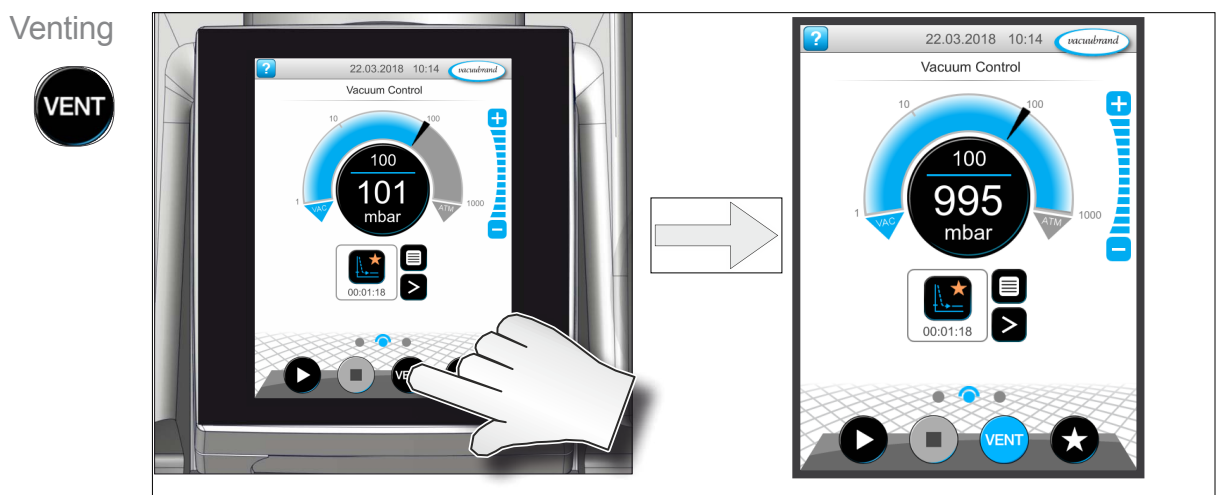

5.2.2 Operation with gas ballast

Meaning

The provision of gas ballast (= addition of gas) ensures that vapors do not condense inside the vacuum pump but are instead ejected from the pump. This makes it possible to pump larger amounts of condensable vapors and service lives are prolonged. The ultimate vacuum with gas ballast is slightly higher.

Open/close gas ballast valve

Operate gas ballast valve

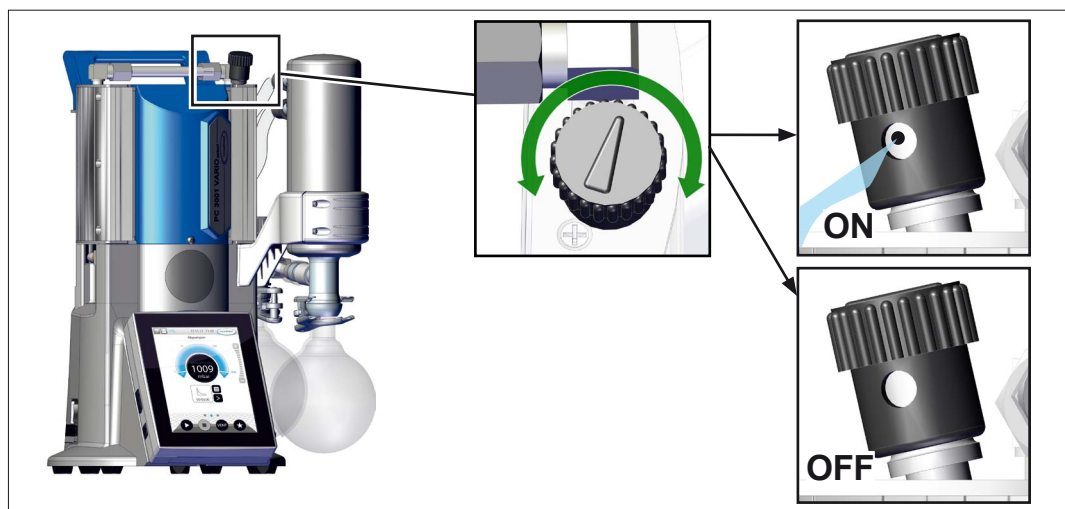

- ⇒ Turn the black gas ballast cap in any direction to open or close the gas ballast valve.
- ⇒ Evacuate condensable vapors, e. g., water vapor, solvents, etc. preferably only with the vacuum pump at operating temperature and with the gas ballast valve open.

IMPORTANT!

- ⇒ Connect inert gas as a gas ballast, if necessary, to exclude the formation of explosive mixtures.
- ⇒ Observe the admissible pressure at the gas ballast connection, max. 1.2 bar/900 Torr abs.



If the gas volume in the vacuum pump is low, a gas ballast can, where appropriate, be eliminated in these cases in order to increase the solvent recovery rate.

5.3 Decommissioning (switch off)

Take pumping unit out of operation

Switch-off pumping unit

1. Stop the process and allow the pumping unit to run for approx. 30 minutes, with open gas ballast or open inlet (IN).
 - Condensate and residual media are rinsed from the vacuum pump.

IMPORTANT! ⇒ Prevent deposits and rinse condensate out of the pump.

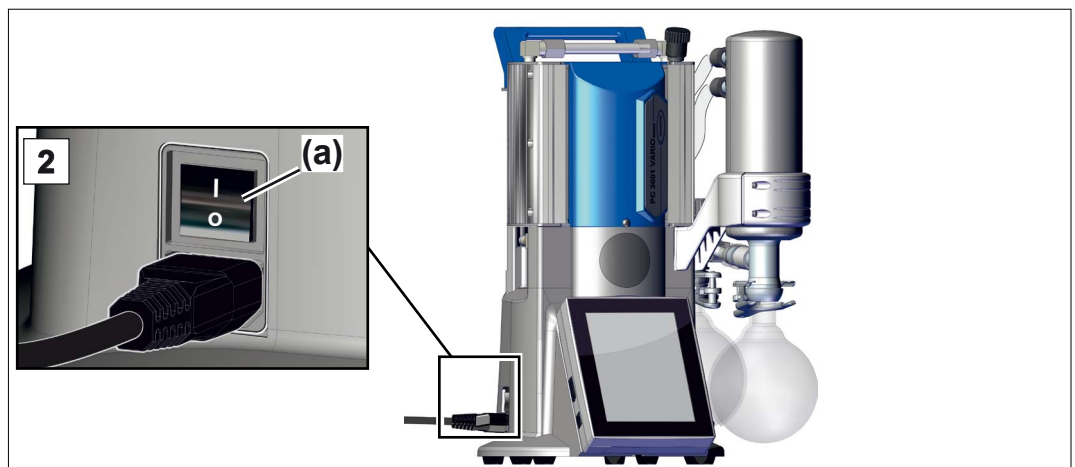

2. Switch the rocker switch **(a)** off – switch position **O**.
 - Pumping unit switched off.
3. Disconnect the pumping unit from the apparatus.
4. Empty the glass flasks.
5. Check the pumping unit for possible damage and pollution.

5.4 Storage

Store pumping unit

1. Clean the vacuum pumping unit when it is polluted.
2. Recommendation: Perform a preventive maintenance before storing the pumping unit. Especially if it ran more than 15000 operating hours
3. Close the suction and exhaust connections, e. g., with protection caps.
4. Package the pumping unit such that it is protected from dust; possibly enclose desiccants.
5. Store the vacuum pumping unit in a cool, dry location.

IMPORTANT!

If damaged parts are stored for operational reasons, these should be clearly identified as **not ready for use**.

6 Troubleshooting

6.1 Technical support

⇒ To identify errors and potential remedies, please refer to the troubleshooting table *Error – Cause – Remedy*.

For technical assistance or errors for which you require additional support, please contact your local distributor or our [Service Department](#)¹.



Operate the machine only when it is in proper working condition.

- ⇒ Observe the recommended maintenance intervals and thus ensure a functional system.
- ⇒ Send defective devices to our Service Department or your local supplier for repair!

6.2 Error – Cause – Remedy

Error	▶ Possible cause	✓ Remedy	Personnel
Readings deviate from the reference standard	<ul style="list-style-type: none"> ▶ Vacuum sensor polluted. ▶ Moisture in the sensor ▶ Defective sensor. ▶ Sensor measures incorrectly. 	<ul style="list-style-type: none"> ✓ Clean sensor measuring chamber. ✓ Allow sensor measuring chamber to dry, e. g., through pumping. ✓ Calibrate sensor with reference gauge. ✓ Replace defective parts. 	Specialist
Sensor does not pass on measured value	<ul style="list-style-type: none"> ▶ No voltage applied. ▶ VACUU·BUS plug-in connection or cables defective or not connected. 	<ul style="list-style-type: none"> ✓ Check VACUU·BUS plug-in connection and cables to the controller. 	Operator
	<ul style="list-style-type: none"> ▶ Defective sensor. 	<ul style="list-style-type: none"> ✓ Replace defective parts. 	Specialist



¹ -> Phone: +49 9342 808-5660, fax: +49 9342 808-5555, service@vacuubrand.com

Error	▶ Possible cause	✓ Remedy	Personnel
Venting valve does not operate	<ul style="list-style-type: none"> ▶ No voltage applied. ▶ VACUU·BUS plug connection or cables defective or not connected. ▶ Venting valve polluted. ▶ Venting valve inside the sensor defective. 	<ul style="list-style-type: none"> ✓ Check VACUU·BUS plug connection and cables to the controller. ✓ Clean venting valve. ✓ If necessary, use another external venting valve. 	Specialist
Vacuum pump does not start.	<ul style="list-style-type: none"> ▶ Overpressure in the exhaust gas line. ▶ Condensation in the vacuum pump. 	<ul style="list-style-type: none"> ✓ Open up exhaust gas line. ✓ Ensure a clear passage. ✓ Flushing: Operate vacuum pump briefly with open suction nozzle and max. speed. 	Operator
	<ul style="list-style-type: none"> ▶ Pumping unit switched off. ▶ Power plug or plug-in power supply not correctly plugged in or pulled out. ▶ VACUU·BUS plug connection or cables defective or not connected. 	<ul style="list-style-type: none"> ✓ Switch pumping unit on using rocker switch. ✓ Check power supply and cable. ✓ Check VACUU·BUS plug connection and cables to the controller. 	Operator
	<ul style="list-style-type: none"> ▶ Motor overloaded. ▶ Thermal protection triggered. 	<ul style="list-style-type: none"> ✓ Check coolant connection. ✓ Ensure coolant supply. ✓ Allow the motor to cool off. ✓ Reset error manually: <ul style="list-style-type: none"> → Unplug pumping unit from mains → Eliminate cause of error → Switch pumping unit back on. 	Specialist

Error	▶ Possible cause	✓ Remedy	Personnel
No or very little suction power	▶ Leak in the suction line or in the apparatus.	✓ Check suction line and system for possible leaks.	Operator
	▶ Condensate collection bottle not mounted properly.	✓ Check condensate flask and its correctly fixation. ✓ Check apparatus for leaks.	
	▶ Vacuum line too long.	✓ Use vacuum lines with a larger cross-section.	resp. Specialist
	▶ Condensate inside the vacuum pump.	✓ Allow vacuum pump to run for a few minutes with the suction nozzle open.	Operator
	▶ Deposits inside the vacuum pump	✓ Clean and check pump heads.	Specialist
	▶ Diaphragms or valves defective.	✓ Replace defective parts.	Specialist
	▶ High level of vapor generated in the process.	✓ Check process parameter.	Specialist
	▶ Gas ballast open	✓ Close gas ballast	Operator
No display	▶ Gas ballast cap porous or no longer present.	✓ Check gas ballast cap. ✓ Replace defective parts.	Operator
	▶ Pumping unit switched off. ▶ Power plug or plug-in power supply not correctly plugged in or pulled out. ▶ VACUU·BUS plug connection or cables defective or not connected. ▶ Controller switched off or defective.	✓ Switch pumping unit on using rocker switch. ✓ Check power supply and cable. ✓ Check VACUU·BUS plug connection and cables to the controller. ✓ Replace defective parts.	Operator
Loud operating noises	▶ No hose installed.	✓ Check hose and install it right.	Operator

Error	▶ Possible cause	✓ Remedy	Personnel
Loud operating noises	<ul style="list-style-type: none"> ▶ Ball bearing defective. ▶ Outlet pipe open. 	<ul style="list-style-type: none"> ✓ Maintain vacuum pump and replace defective parts. ✓ Check exhaust gas line connections. ✓ Connect the outlet pipe to an exhaust system, e. g., fume hood. ✓ Glass flask on EK missing. 	Specialist
Condenser (cooler) defective	▶ Mechanically damaged.	✓ Send in.	resp. Specialist

7 Cleaning and maintenance

	WARNING
	<p>Danger due to electrical voltage.</p> <ul style="list-style-type: none"> ⇒ Switch the device off before cleaning or performing maintenance on the device. ⇒ Pull out power plug.
	<p>Risk of injury because of toxic contaminated parts.</p> <p>Pumping hazardous media can result in hazardous substances adhering to parts on the inside of the pump.</p> <ul style="list-style-type: none"> ⇒ Wear your personal protective equipment, e. g., protective gloves, eye protection and, if necessary, respiratory protection. ⇒ Decontaminate the vacuum pump before opening it. If necessary, have it decontaminated by an external service provider. ⇒ Take safety precautions according to your directives for handling hazardous substances.

NOTICE

Damage possible if work is performed incorrectly.

- ⇒ Have maintenance work performed by a trained professional or at least by a trained person.
- ⇒ Recommendation: Please read before the first maintenance the complete instructions once to get an overview of the required service activities.

7.1 Information on service work

Recommended maintenance intervals

Maintenance intervals*	if required	15000 h
Replace diaphragms		X
Replace valves		X
Clean or replace molded PTFE-hose	X	
Cleaning Pumping unit	X	

* Recommended maintenance interval after hours of operation and under normal operating conditions; depending on the environment and area of application, we advise performing cleaning and maintenance as needed.

Recommended auxiliaries

→ Example
Recommended aids
for cleaning and
maintenance



Nr	Auxiliary materials
1	Round bottom flask stand
2	Glass pipette
3	Protective gloves
4	Chemically resistant vessel + funnel

IMPORTANT!

⇒ Always wear your personal protective equipment when performing activities during which you can come into contact with hazardous substances.

Tools needed for maintenance

→ Example
Tool



Nr	Tool	Size
1	Flat-head screwdriver Open hose clamps	Gr. 1
2	Torx screwdriver Screw connections counterholder EK or IK	TX10
3	Fork wrench Knurled nut M14 Rotate elbow union	SW17 SW14
4	Phillips screwdriver Screw connections holder, TE or EKP	Gr. 2
5	Flat nose pliers Close hose clamps	
6	Allen key Screw connections handle Screw connections housing cover Sensor fastening screws	Gr. 5 Gr. 4 Gr. 3
7	Set of seals MD 1C #20696828 Diaphragm wrench Diaphragm Valves	SW46

7.2 Cleaning

IMPORTANT!

This chapter does not contain descriptions for the decontamination of the product. This chapter describes simple cleaning and care measures.

⇒ Before cleaning, switch off the Pumping unit.

7.2.1 Housing surface

Clean surface



Clean polluted surface with a clean, slightly moistened cloth. To moisten the cloth we recommend water or mild soap.

7.2.2 Empty glass flask

Remove and empty glass flask

→ Example
Empty glass flask

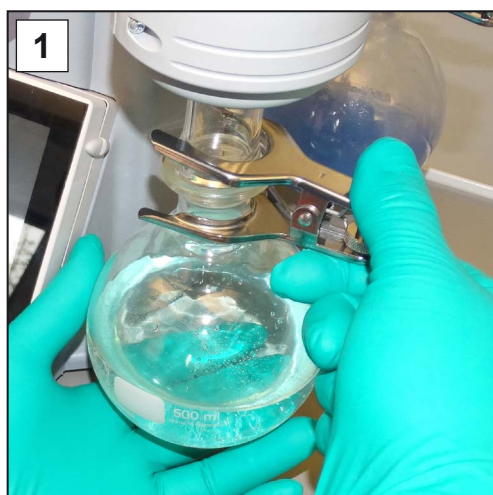

1. Open the joint clamp and remove the glass flask.

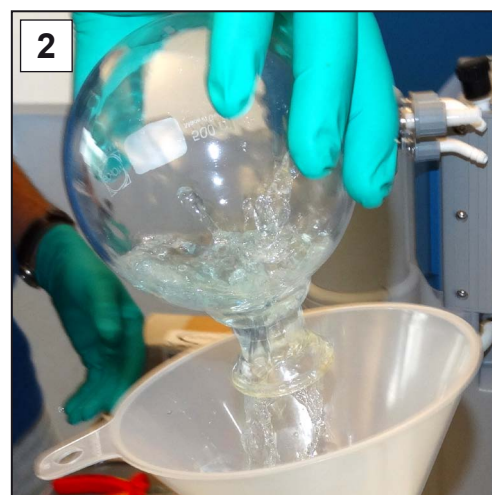

2. Empty the glass flask into a suitable container, e. g., chemical-resistant canister.

3. Then fix the glass flask to the condenser once again using the joint clamp.



Depending on the application, the collected liquid can either be reprocessed or professionally disposed of.

7.2.3 Clean sensor and venting valve

In the case of incorrect measurements or malfunction which suggest soiling of the sensor and/or venting valve, we recommend cleaning the sensor and venting valve. We recommend to clean the sensor prior to adjustment.

Remove sensor

→ Example
Remove sensor



1. Switch the Pumping unit off and disconnect the power plug.

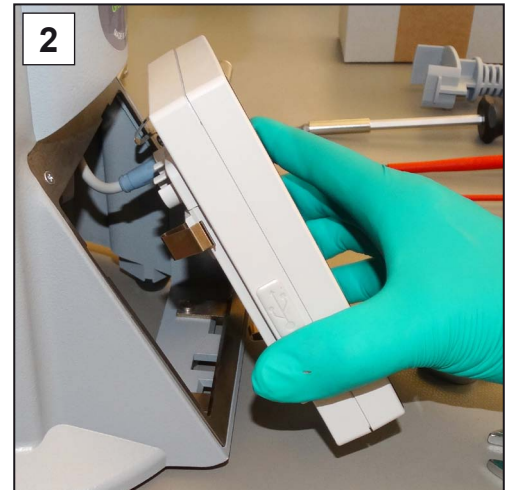

2. Take the vacuum controller out of the housing and pull out the connected VACUU-BUS plug.

3. Remove the glass flasks and place them on a suitable flask stand.

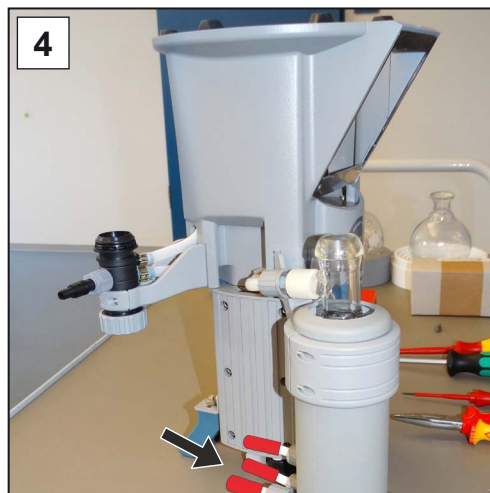

4. Close the hose nozzles of the cooler and carefully turn the Pumping unit upside down.



5. Open the knurled nuts on the sensor; open-end wrench SW17, and remove the molded hose.

→ Example
Remove sensor

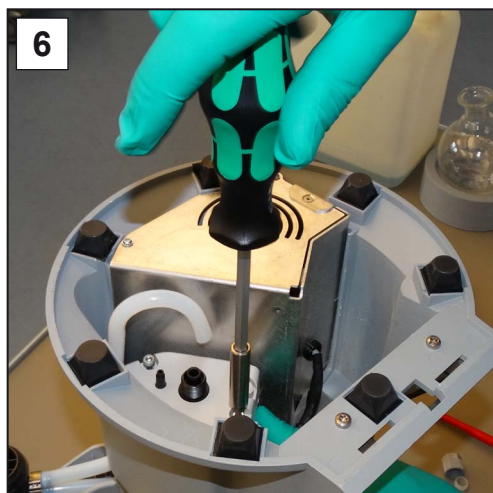

6. Unscrew in the fastening screws; Allen key size 3



7. Pull out the VACUU·BUS plug downwards and remove the sensor.

Clean sensor

→ Example Clean
measurement
chamber and venting
valve

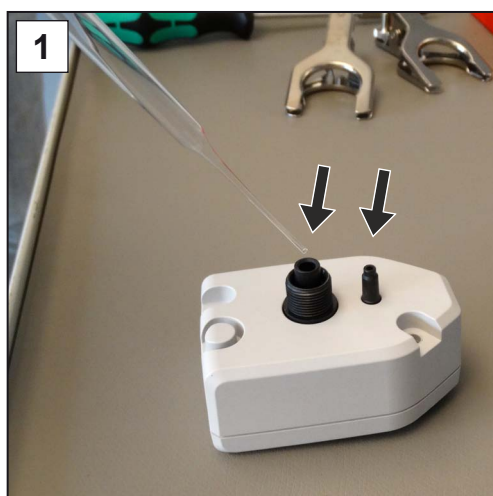

1. Using a pipette, fill a small amount of solvent, e. g., cleaning solvent, into the openings.



2. Let the solvent react for a few minutes before draining it.

- 3.** Repeat this procedure until no more pollutants are in the solvent.
- 4.** Allow the inside of the sensor air-dry or dry under a vacuum.

Install sensor

→ Example
Mount sensor

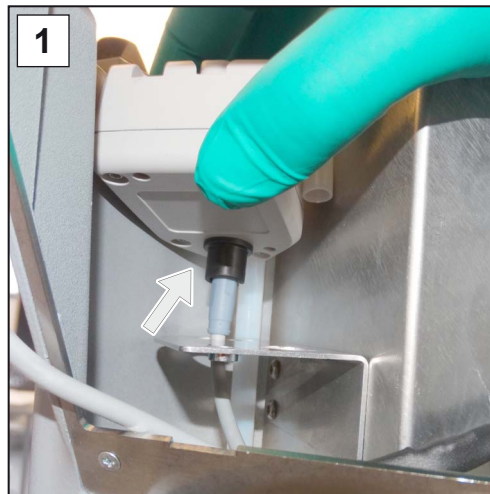

1. Insert the VACUU-BUS plug and place the sensor on the holder.

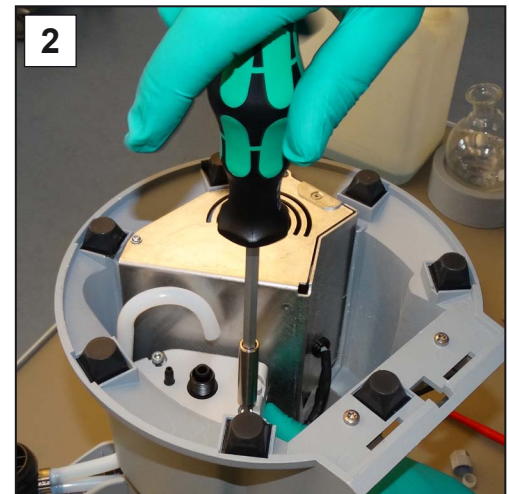

2. Insert the fastening screws and screw them in hand-tight; Allen key Sz. 3

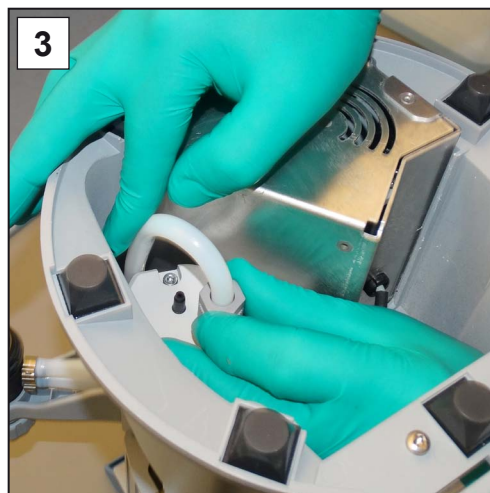

3. Push the molded hose onto the connection and screw the knurled nut on hand-tight; open-end wrench SW17.



4. Turn the pumping unit around to the proper position and connect the cables: VACUU-BUS, power plug.

5. Secure the glass flasks using the joint clamp.

6. Switch on the pumping unit and the vacuum controller.

Recommendation: Readjust the sensor if incorrect values are displayed → see *manual of the vacuum controller* .

7.2.4 Clean or replace molded PTFE-hose

Maintenance provides the opportunity to check the components of the Pumping unit, including the tubing.

- ⇒ Clean the inside of heavily polluted molded hoses, e. g., using a pipe cleaner or the like.
- ⇒ Replace brittle and defective molded hoses.

7.3 Vacuum pump maintenance

7.3.1 Maintenance items

Items to be maintained

→ Example
Maintenance of the
pump heads

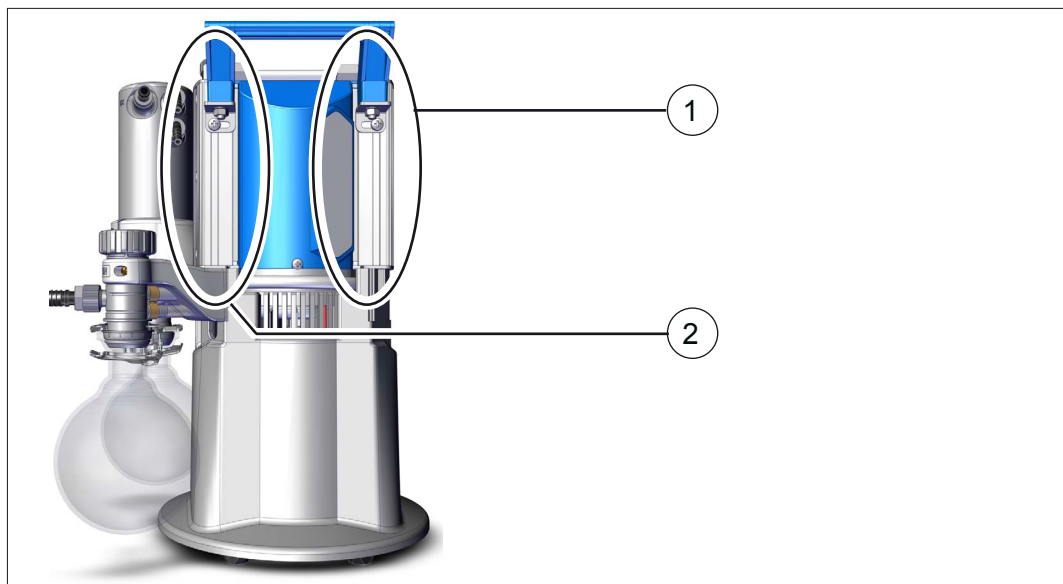

Maintenance items

- | | |
|---|--------------------------------------|
| 1 | Housing cover, power connection side |
| 2 | Housing cover with gas ballast |

IMPORTANT!

- ⇒ Perform maintenance of the pump heads one after the other
- ⇒ In the case of the pump heads, always change the diaphragms and valves completely, as shown in the image description for pump head **(1)**.



- Easy maintenance because of splitted work steps.
- ⇒ First, replace the diaphragms off one pump head.
 - ⇒ Then change the inlet/outlet valves.
 - ⇒ Then perform these activities at the next pump head.

Exploded-view sketch of pump head (example)

→ Example
Exploded-drawing
pump head

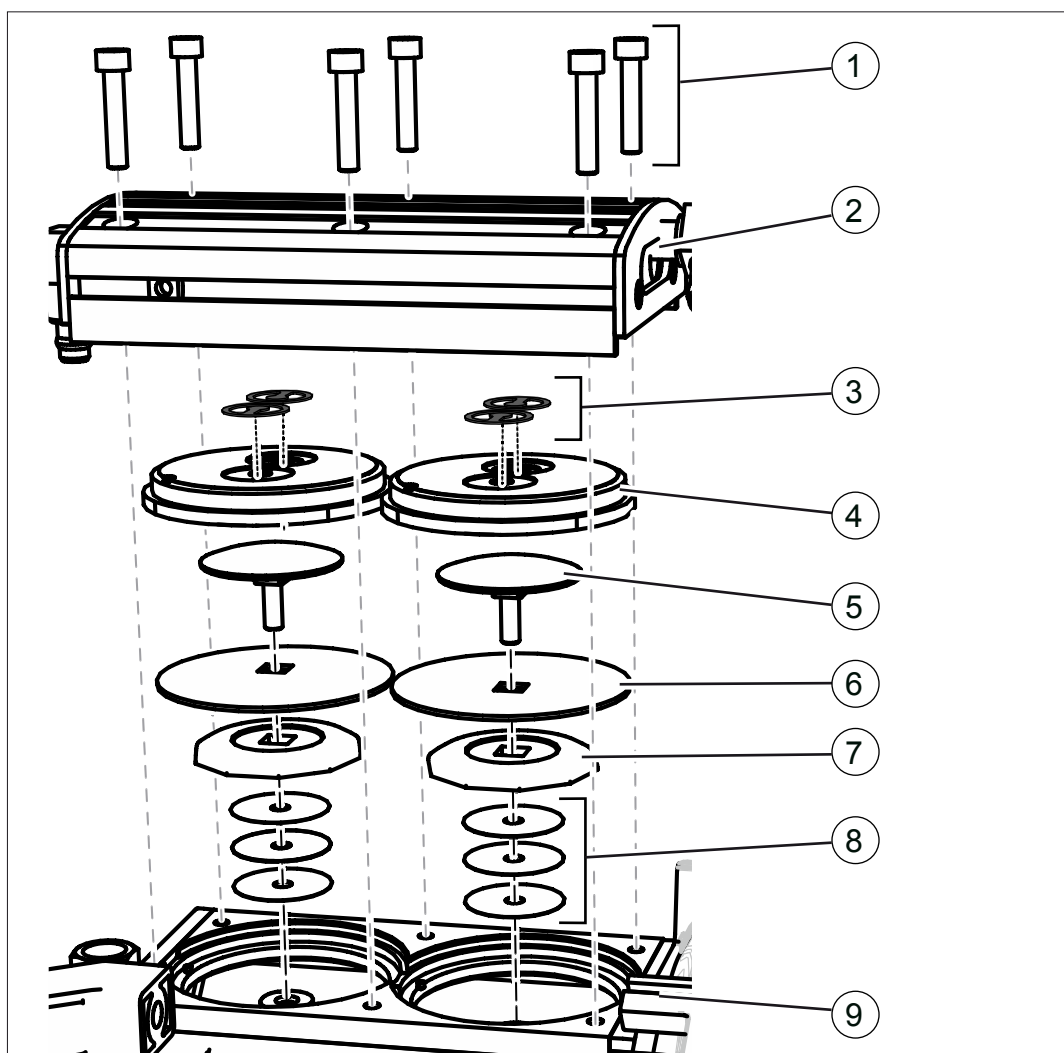

Valve maintenance

- 1 Screw connections
- 2 Housing cover
- 3 Valves

Diaphragm maintenance

- 4 Head cover
- 5 Diaphragm clamping disc with square-head screw
- 6 Diaphragm
- 7 Diaphragm support disc
- 8 Spacer discs, max. 4 pieces
- 9 Pumping unit

7.3.2 Change diaphragms and valves

Preparation

→ Example
Prepare
maintenance



1. Switch the Pumping unit off and disconnect the power plug.

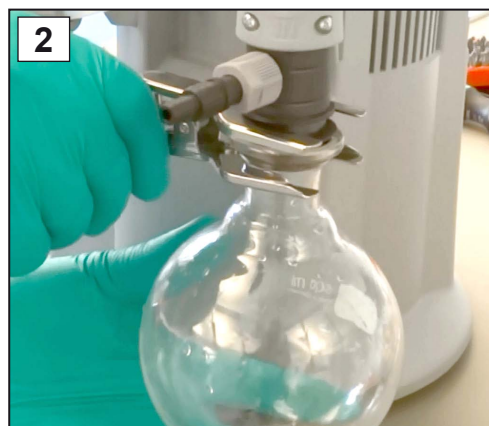

2. Remove the glass flasks as well as connected hoses (coolant, vacuum).

→ Example
Disassemble EK (IK)



3. Unscrew the screws from the counterholder;
Torx screwdriver TX10

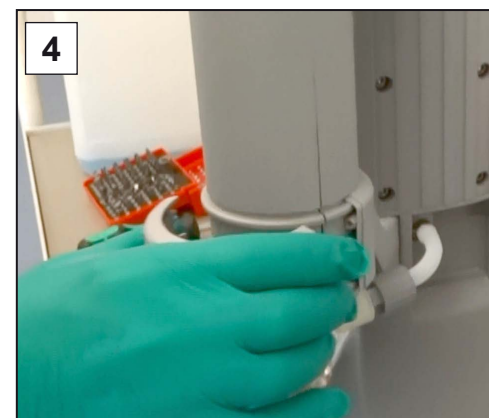

4. Remove the counterholder and lay it aside together with the screws.



5. Screw in the nut only hand-tight.



6. Remove the cooler.



7. Set the cooler down securely so that no liquid can escape.



⇒ The chiller TE and EKP type are fixed by metal plate.
⇒ In the case of these coolers, detach the screws of the retaining plates on the pumping units.

→ Example
Disassemble TE or
EKP

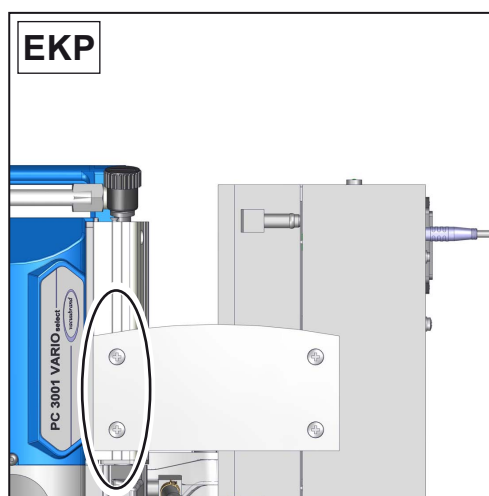

⇒ Unscrew the 2 fastening screws; Phillips screwdriver 2.

Disassemble device and housing parts

→ Example
Disassemble
housing parts on left



1. Loosen the knurled nut; open-end wrench SW17.



2. Turn the elbow union a quarter turn to the side; open-end wrench SW14.



3. Loosen the screw connection from the handle; Allen key 5.



4. Lay the Pumping unit carefully on its side.



5. Open the hose clamp; flat-head screwdriver 1.



6. Unscrew the screw connections from the housing cover; Allen key 4.

→ Example
Disassemble
housing parts on left



7. Lift the housing cover and remove the molded hose.



8. Check the housing cover for sticking valves and place the housing cover with the screw connections on the side.

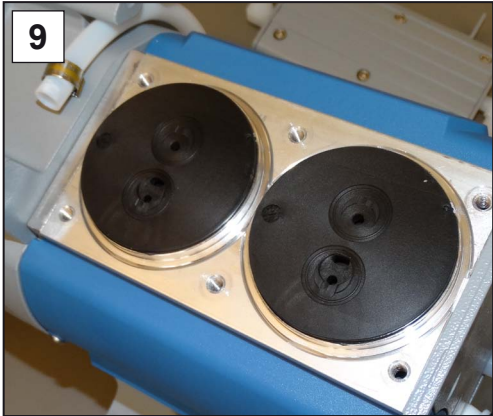

9. Note the position of the head covers.

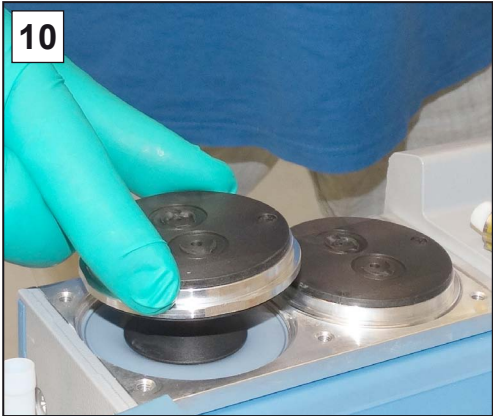

10. Remove the head covers.

IMPORTANT!

Valves must be correctly positioned, otherwise the vacuum pump will not generate any vacuum.

Replace diaphragm

→ Example
Diaphragm
replacement

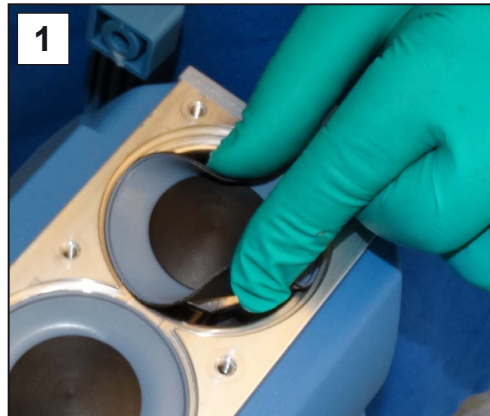

1. Fold the diaphragm on the sides upwards.

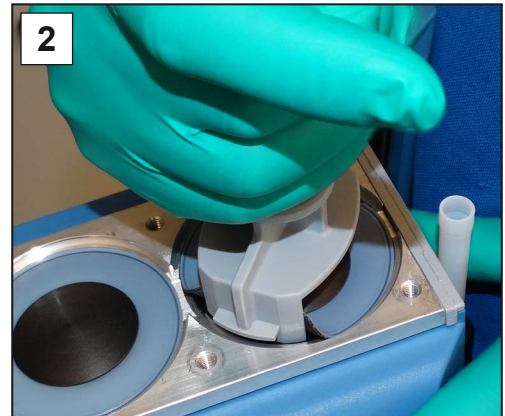

2. Carefully position the diaphragm key on the diaphragm support disc.

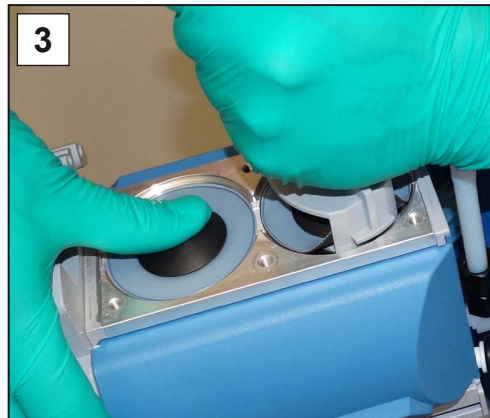

3. Unscrew the assembly with the attached diaphragm key.



4. Lift the diaphragm with all parts out of the vacuum pump. If spacer discs adhere to the connecting rod, remove them carefully.

IMPORTANT!

- ⇒ Never let drop spacer discs into the housing.
- ⇒ Keep the spacer discs. The same number of spacer discs must be reinserted.

→ Example
Diaphragm
replacement

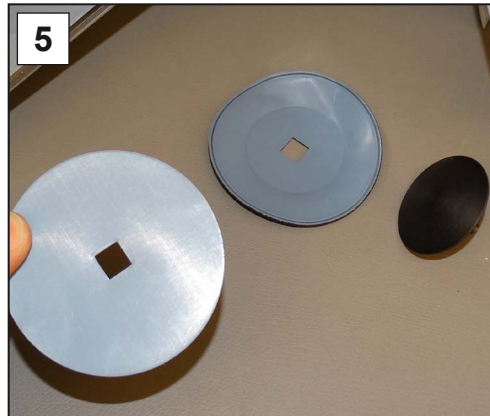

5. Disassemble the assembly and take a new diaphragm; seal set MD 1C.

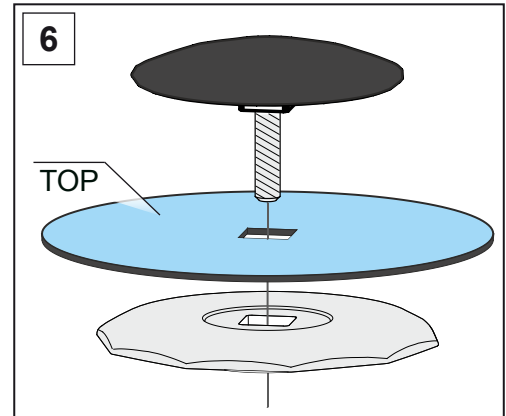

6. Ensure that the diaphragm is inserted correctly, with the coated, light-colored side facing up.

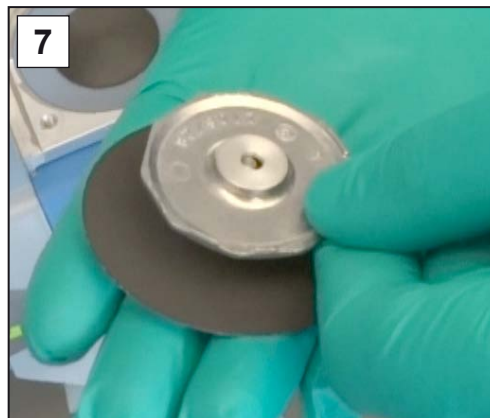

7. Pay special attention to the correct fitting onto the square of the thread.

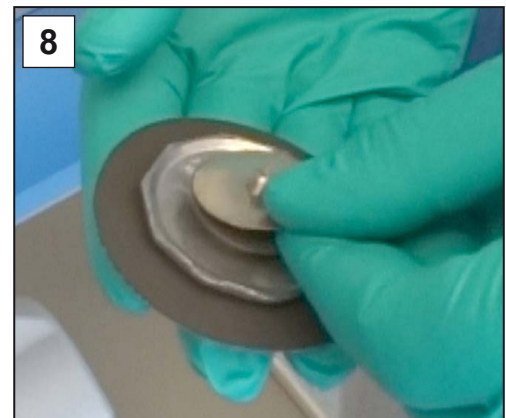

8. Position the correct number spacer discs.



9. Fixate the diaphragm assembly in the diaphragm key.



10. Hold the spacer discs firmly and place the assembly on the rod thread.

→ Example
Diaphragm
replacement

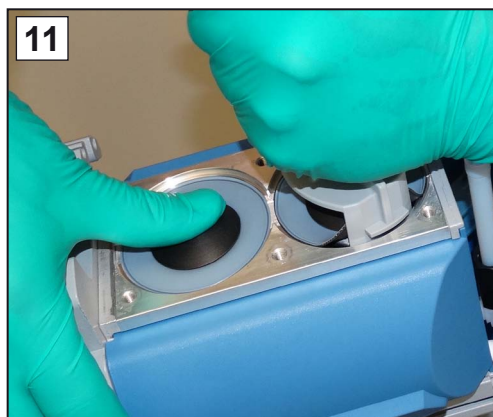

11. Tighten the assembly hand-tight using the diaphragm key.

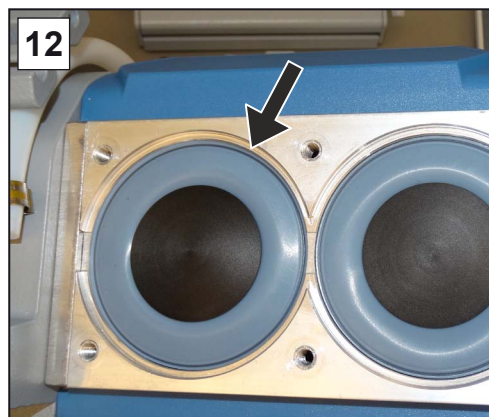

12. Repeat the process for the second diaphragm.

Change valves

→ Example
Valve replacement

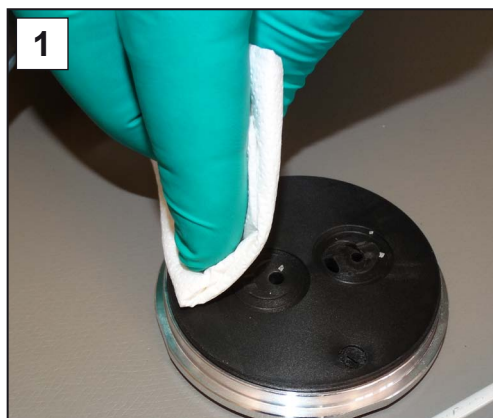

1. Clean dirty head covers and

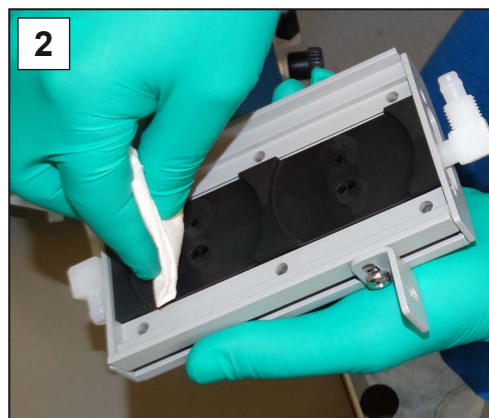

2. housing cover carefully using a cloth.

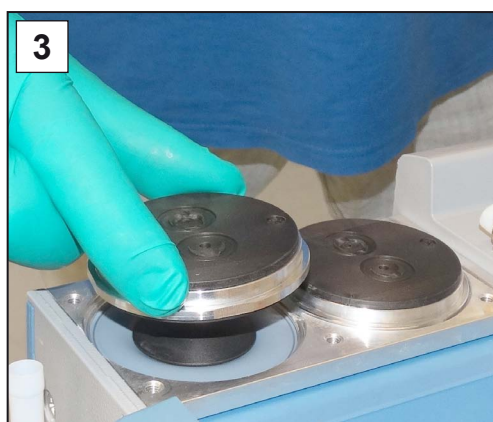

3. Place both head covers in the correct position.

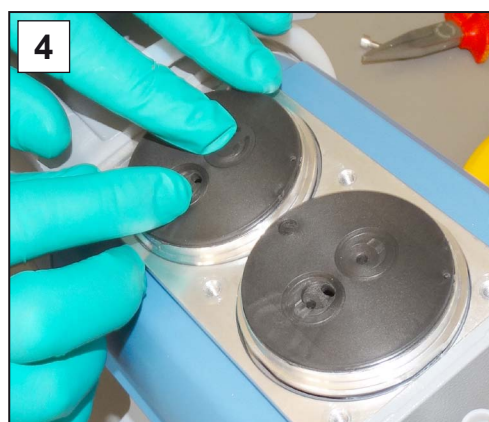

4. Position the new valves and align them; sealing set MD 1C.

→ Example
Valve replacement

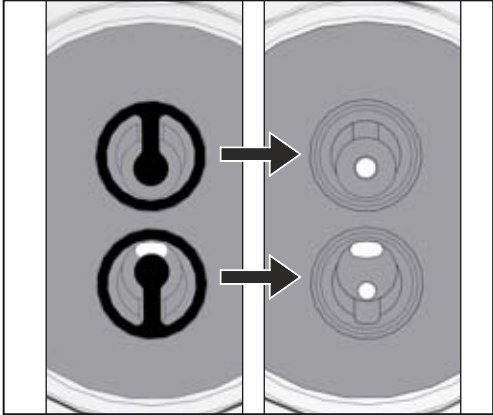

Top view cutout: Proper positioning of the valves.



5. If all valves are correctly positioned, first insert the molded hose.



6. Place the housing cover as well and screw in the screw connections; Allen key 4, tightening torque, 6 Nm.

Changing the diaphragm and valve of the next pump head

→ Example
Maintenance of the
second pump head



- ⇒ Turn the pumping unit to the other side.
- ⇒ Repeat the steps from the previous descriptions for changing the diaphragm and valve.

Assemble device and housing parts

Before putting the pumping unit back into service, all device and housing parts which had been previously removed must first be fixed once again.

→ Example
Assemble device
and housing parts



1. Position the pumping unit.

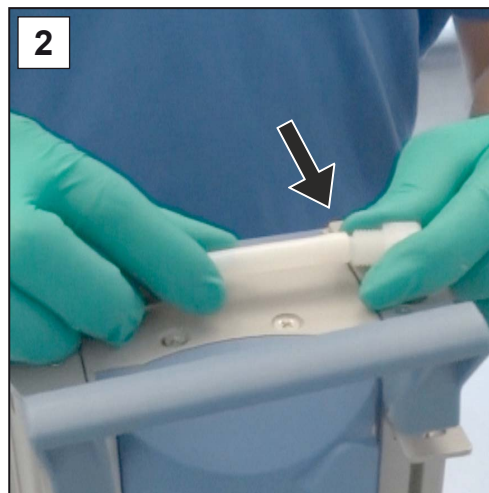

2. Turn the elbow union a quarter turn back into the molded hose.



3. Tighten the knurled nut hand-tight; fork wrench SW17.

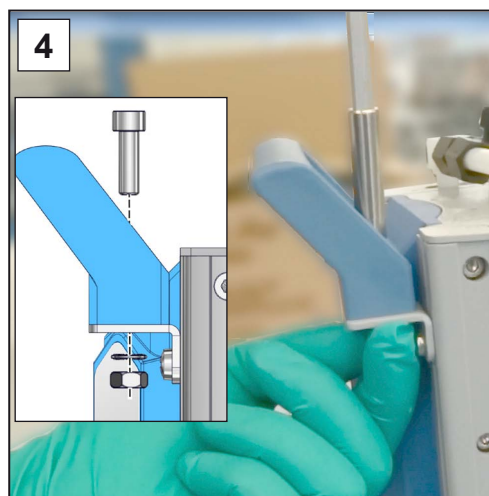

4. Fix the handle; Allen key 5.



5. Close the open hose clamps using the flat nose pliers.



6. Attach the molded hose and tighten the knurled nut hand-tight.



7. Secure the counterholder; Torx screwdriver TX10.
For EKP or TE, screw on the retaining plate; Phillips screwdriver 2.



8. Fasten the glass flasks using the joint clamp.

If the maintenance work is completed in full:

- ⇒ Connect the hose system for operation.
- ⇒ Connect the pumping unit to the power supply.
 - Pumping unit ready to return to service.

Without reconnection:

- Pumping unit prepared for storage.

8 Appendix

8.1 Technical information

Chemistry pumping units	
PC 3001 VARIO select	PC 3001 VARIO select IK
PC 3001 VARIO select TE	PC 3001 VARIO select EKP

8.1.1 Technical data

Technical data

Ambient conditions		(US)
Ambient temperature, max.	10–40 °C	50–104°F
Operating temperature	10–40 °C	50–104°F
Transport and storage temperature	-10–60 °C	14–140°F
Altitude, max.	3000 m above sea level	9840 ft above sea level
Relative humidity	30–85 %, non condensing	
Protection type	IP 20 / IK 08	

Operating conditions		(US)
Maximum admissible media temperature (gas), non-explosive atmosphere:		
momentarily	80 °C	176°F
Continuous operation	45 °C	113°F
ATEX conformity	II 3/- G IIC T3 X Internal Atm. only	
Maximum admissible media temperature (gas)  atmosphere:		
momentarily	40 °C	104°F
Continuous operation	40 °C	104°F

Connections	
Vacuum inlet IN	Hose nozzle DN 6/10
Gas ballast	Gas ballast valve, manual
Inert gas adapter – OPTION	Small flange GB NT KF DN 16 Hose nozzle GB NT DN 6/10
Venting valve (venting with inert gas) – OPTION	Silicone rubber hose 3/6
Coolant water EK (+IK)	2x (+2x) Hose nozzle DN 6/8
Exhaust gas, outlet EX	Hose nozzle DN 8/10

Cold-device plug	+ Power supply CEE, CH, CN, UK, IN, US
Plug-in connector	VACUU·BUS®

Technical data

Electrical data		(US)
Nominal voltage	200-230 VAC	100-120 VAC
Frequency	50 Hz	60 Hz
Nominal current at 50 Hz	0,7 A	1.6 A
Capacity, max.	0,16 kW	0.16 kW
Interface	VACUU·BUS®	
Power cable	2 m	

Vacuum data		(US)
Max. Pumping speed	2,0 m³/h	1.18 cfm
Ultimate vacuum, abs.	2,0 mbar	1.5 Torr
Ultimate vacuum with GB, abs.	4 mbar	3 Torr
Max. Inlet pressure, abs.	1,1 bar	825 Torr
Max. Outlet pressure, abs.	1,1 bar	825 Torr
Max. Differential pressure, abs.	1,1 bar	825 Torr
Max. Max. pressure at gas connections, abs.	1,2 bar	900 Torr
Number of cylinders/stages	4/3	4/3
Sensor	integriert	integrated
Measuring principle	Ceramic diaphragm (aluminum oxide), capacitive, gas type independent, absolute pressure	
Accuracy of measurement	±1 mbar/hPa/Torr, ±1 digit (after adjustment, constant temperature)	
Upper measurement limit	1080 mbar	810 Torr
Lower measurement limit	0,1 mbar	0.1 Torr
Temperature coefficient	< 0,15 mbar/hPa	0.11 Torr/K

Weights* and dimensions (l x b x h)		(US)
PC 3001 VARIO select	303 mm x 306 mm x 400 mm	12.05 in x 11.93 in x 15.75 in
Weight*	8,2 kg	18.08 lb
PC 3001 VARIO select TE	300 mm x 341 mm x 493 mm	11.81 in x 13.43 in x 19.41 in
Weight*	8,7 kg	19.18 lb
PC 3001 VARIO select IK	309 mm x 312 mm x 400 mm	12.17 in x 12.28 in x 15.75 in
Weight*	8,8 kg	19.4 lb
PC 3001 VARIO select EKP	300 mm x 370 mm x 400 mm	11.81 in x 14.57 in x 15.75 in
Weight*	11,8 kg	26.01 lb

* without cable

Other information	
Sensor type	VACUU·SELECT Sensor
Controller	VACUU·SELECT
Volume of separator (glass flask)	á 500 ml
Sound pressure level at 1500 rpm/62% (VARIO)	42 dBA

8.1.2 Wetted materials

Wetted materials

Component	Wetted materials
Pump	
Housing cover	PTFE
Head cover	ETFE, carbon-fiber-reinforced
Diaphragm clamping disc	ETFE, carbon-fiber-reinforced
Diaphragm	PTFE
Valves	FFPM
Pumping unit	
Inlet	PPS (IK: PP)
Outlet	PET (PC 3001 without EK: PTFE carbon-fiber-reinforced)
Hoses	PTFE
Hose fittings	ETFE, ECTFE
O-ring on separator	Fluoroelastomer
Overpressure valve on vapor condenser	Silicone rubber, PTFE film
Distributor head (inlet)	PPS, glass-fiber-reinforced, PP (blind plate)
Condenser IK, EK, TE	Borosilicate glass
Round bottom flask	Borosilicate glass
Emission condenser Peltronic	ETFE, ECTFE, PP, PA
Silencer	PBT, PVF, rubber
VACUU·SELECT Sensor	
Vacuum sensor	Aluminium oxide ceramics, gold-coated
Measurement chamber	PPS
Small flange	PP
Sealing ring at the sensor	chemically resistant fluorelastomer
Hose nozzle	PP
Seal on the venting valve	FFPM

8.1.3 Rating plate

Data on rating plate



 ⇒ In the event of an error, make a note of the type and serial number on the rating plate.

⇒ When contacting our Service Department, please provide the type and serial number from the rating plate. This will allow us to provide you with specific support and advice for your device.

Pating plate pumping unit, in general

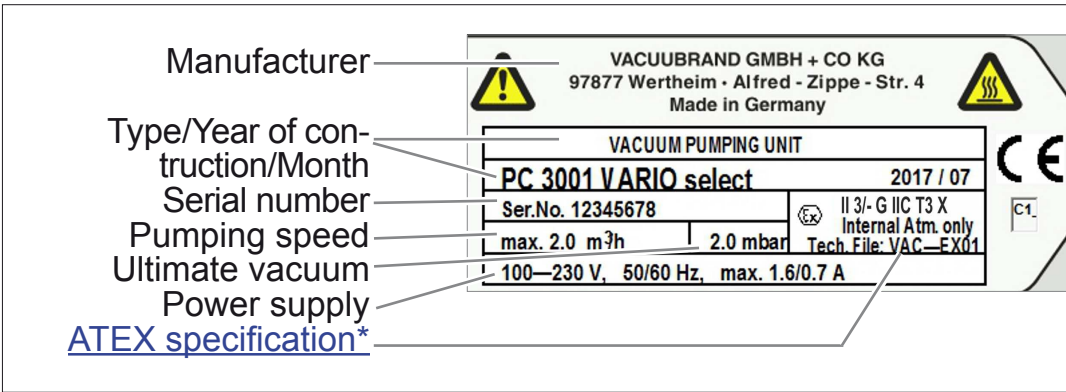
→ Example
Detail Rating plate



Manufacturer	VACUUBRAND GMBH + CO KG 97877 Wertheim · Alfred - Zippe - Str. 4 Made in Germany		
Type/Year of construction	VACUUM PUMPING UNIT PC 3001 VARIO select		2017 / 07
Serial number	Ser.No. 12345678		II 3/- G IIC T3 X Internal Atm. only Tech File: VAC-EX01
Pumping speed	max. 2.0 m ³ /h	2.0 mbar	
Ultimate vacuum	100—230 V, 50/60 Hz, max. 1.6/0.7 A		
Power supply			
ATEX specification*			

* Documentation, group and category, marking G (gas), type protection, explosion group, temperature class (additionally see : [Approval for ATEX equipment](#)).

8.2 Ordering information

Ordering information
pumping unit

Chemistry pumping units		Order no.
PC 3001 VARIO select	CEE	20700200
	CH	20700201
	UK	20700202
	US	20700203
	CN	20700206
	IN	20700207

Ordering information
accessories

Accessories		Order no.
Vacuum hose DN 6 mm (l = 1000 mm)		20686000
Vacuum hose DN 8 mm (l = 1000 mm)		20686001
Coolant valve VKW-B		20674220
Venting valve (air admittance valve) VBM-B		20674217
Level sensor		20699908
VACUU·SELECT Sensor		20612881
VSK 3000		20640530
DAkKS calibration with first delivery		20900214
DAkKS recalibration		20900215

Ordering information
spare parts

Spare parts		Order no.
Hose nozzle 6 rounded		20639948
Hose nozzle DN 6/10		20636635
Small flange KF DN 16		20635008
Extension cable VACUU·BUS, 0.5 m		20612875
Extension cable VACUU·BUS, 2 m		20612552
Extension cable VACUU·BUS, 10 m		22618493
Joint clip VA KS35/25		20637627
Glass flask/round bottom flask 500 ml		20638497
Knurled nut M14x1 (union nut)		20637657
PA Locking ring for knurled nut		20637658
Vapor condenser EK, complete		20699922
Dry ice condenser TE		on request
Immission condenser IK		20636256
Peltronic® emission condenser EKP		20636298
Anti-rotation protection D17x17.5		20635113
Gas ballast cap		20639223
Power cable	CEE	20612058
	CH	20676021
	CN	20635997
	IN	20635365
	UK	20612065



⇒ A full list of available spare parts is available under → VACUUBRAND > Support > Repair instructions > [Chemistry pumping units](#).

Sources of supply

International sales offices and distribution

Purchase original accessories and original spare parts from a subsidiary of **VACUUBRAND GMBH + CO KG** or your local distributor.



- ⇒ Information about our complete product range is available in the current [product catalog](#).
- ⇒ Your local distributor or **VACUUBRAND GMBH + CO KG sales office** is available to assist you with orders, questions on vacuum control and optimal accessories.

8.3 Service

Service offer and
service range

Take advantage of the comprehensive range of services available from
VACUUBRAND GMBH + CO KG.



Services in detail

- Product consultation and practical solutions
- Fast delivery of spare parts and accessories
- Professional maintenance
- Immediate repairs processing
- On-site service (on request)
- Calibration (DAkkS-accredited)
- With Health and Safety Clearance form: return, disposal.

⇒ Visit our website for further information:
www.vacuubrand.com.

Service handling

Meet the
terms of service

1. Contact your local distributor or our Service Department.
2. Request an RMA no. for your order.
3. Clean the product thoroughly or if necessary, decontaminate it professionally.
4. Fill out the Health and Safety Clearance form in full.
5. Return your product, including:
 - RMA no.
 - Repair or service order
 - Health and Safety Clearance form
 - Error description.

Return (reshipment)



- ⇒ Reduce downtime, speed up processing. Please have the required data and documents at hand when contacting our Service Department.
- ▶ Your order can be quickly and easily processed.
 - ▶ Hazards can be prevented.
 - ▶ A brief description and/or photos will help locate the source of the error.

8.4 Index

Index	A	Intended use	12
	Abbreviations	L	
	Accessories	Limitation of use	32
	Action step	M	
	Additional symbols	Maintain minimum distance	20
	Assemble device and housing parts	Maintenance of the pump heads . . .	62
	ATEX equipment category	Maintenance of the second pump head	71
	ATEX equipment labeling	22	
	C	Mandatory sign	8
	Clean measurement chamber and	Measurement chamber	76
	venting valve	Minimum distances	31
	Clean surface	Mount sensor	60
	Connect pumping unit electrically . .	O	
	Connect venting valve	Operate gas ballast valve	47
	Coolant connection	Operating elements	
	Cooling with dry ice condenser	Vacuum controller	45
	Copyright ©	Operating hours maintenance	55
	D	Operating panel	10
	Deadlock protection	Operation with gas ballast	47
	Diaphragm replacement	Operator obligations	14
	Disassemble device and housing parts	Ordering information	78
	66	Ordering information pumping unit se-	
	Disassemble EK (IK)	ries	78
	Disassemble housing parts on left . .	Overheating	20
	Disassemble TE or EKP	Overheating protection	21
	Display conventions	Overview	
	Display of action steps	Chemistry pumping units	25
	Distributors	P	
	Dry ice condenser (dry ice cooler) . .	Peripheral devices and ATEX	22
	10	Permissible chill temperatures	36
	E	Personnel obligations	14
	EC Declaration of Conformity	Personnel qualification	15
	Electrical connection	Power cable	42
	Eliminate sources of danger	Prepare maintenance	64
	Empty glass flask	Prevent blocked exhaust gas line . .	18
	Error – Cause – Remedy	Prevent condensate reflow	18
	Exhaust gas connection	Prevent ignition source	22
	Explanation of safety symbols	Process screen (main screen)	45
	Exploded-drawing pump head	Product-specific abbreviations	25
	63	Product-specific terms	10, 11
	F	Prohibition sign	8
	Fill TE with freezing mixture	Proper disposal	23
	Foreseeable misuse	Protective clothing	16
	13	Q	
	G	Qualification description	15
	Goods arrival	Quality commitment	16
	30	R	
	H	Rating plate	77
	Handling instruction	Remove sensor	58, 59
	Health and Safety Clearance form . .	Reset overheat protection	51
	hot surface	Residual energies	19
	20	Responsibility Assignment Matrix . .	15
	I	Responsibility matrix and areas of com-	
	Icons	petence	15
	Improper use	Return (reshipment)	80
	Incorrect measurements		
	Incorrect measurements		
	avoid		
	19		
	Instruction modules		
	6		

Index	Return to service after maintenance	73
	Risks of	
	Venting	19
	Risks with cryogenic substances	21
	Rotary evaporation	29
	S	
	Safety information	12
	Safety Information for Vacuum Equip- ment	12
	Safety precautions	16
	Sensor position	39, 40
	Service handling	80
	Service range	80
	Sources of supply	79
	Spare parts	78
	Specifications	
	Coolant mixtures	36
	Start	46
	Stop	46
	Storage, preparation	73
	Structure of the Operating instructions	6
	Switch-off pumping unit	48
	Switch on pumping unit	44
	Symbols	8
	T	
	Target groups	15
	Technical data	74, 75
	Technical information	74
	U	
	Unpacking	30
	User information	5
	V	
	VACUU·BUS®	10
	VACUU·BUS® connector	10
	Vacuum concentrator	29
	Vacuum connection	33
	Vacuum controller operation	44
	Valve replacement	70
	Valves, pump head	63
	Venting	46
	W	
	Warning sign	8
	Warning signs and labels	21
	Wetted materials	76

8.5 EC Declaration of Conformity

EU-Konformitätserklärung EC Declaration of Conformity Déclaration CE de conformité



Hersteller / Manufacturer / Fabricant:

VACUUBRAND GMBH + CO KG · Alfred-Zippe-Str. 4 · 97877 Wertheim · Germany

Hiermit erklärt der Hersteller, dass das Gerät konform ist mit den Bestimmungen der Richtlinien:

Hereby the manufacturer declares that the device is in conformity with the directives:

Par la présente, le fabricant déclare, que le dispositif est conforme aux directives:

2006/42/EG (M-RL), 2014/30/EU (EMV-RL), 2014/34/EU (ATEX-RL),
2011/65/EU (RoHS-2)

Chemie-Pumpstand-Serie / Chemistry pumping unit series / Groupe de pompage *chimie*

Typ / Type / Type: **PC 3001 VARIO select, PC 3001 TE VARIO select,
PC 3001 EKP VARIO select, PC 3001 IK VARIO select**

Artikelnummer / Order number / Numéro d'article: **20700205, 20700225, 20700245,
20700265**

Seriennummer / Serial number / Numéro de série: Siehe Typenschild / See rating plate / Voir plaque signalétique

Angewandte harmonisierte Normen / Harmonized standards applied / Normes harmonisées utilisées: DIN EN ISO 12100:2011, DIN EN 1012-2:2011, IEC 61010-1:2010 (Ed. 3), DIN EN 61010-1:2011, DIN EN 61326-1:2013, DIN EN 1127-1:2011, DIN EN ISO 80079-36:2016, DIN EN 50581:2013

Bevollmächtigter für die Zusammenstellung der technischen Unterlagen / Person authorised to compile the technical file / Personne autorisée à constituer le dossier technique: Dr. J. Dirscherl · VACUUBRAND GMBH + CO KG · Germany

Ort, Datum / place, date / lieu, date: Wertheim, 29.03.2018

(Dr. F. Gitmans)

*Geschäftsführer / Managing Director /
Gérant*

ppa.

(Dr. J. Dirscherl)

*Technischer Leiter / Technical
Director / Directeur technique*

VACUUBRAND GMBH + CO KG

Alfred-Zippe-Str. 4
97877 Wertheim

Tel.: +49 9342 808-0

Fax: +49 9342 808-5555

E-Mail: info@vacuubrand.com

Web: www.vacuubrand.com



Technology for Vacuum Systems

Manufacturer:

VACUUBRAND GMBH + CO KG
Alfred-Zippe-Str. 4
97877 Wertheim
GERMANY

Phone:

- Head office +49 9342 808-0
- Sales +49 9342 808-5550
- Service +49 9342 808-5660

Fax: +49 9342 808-5555

E-Mail: info@vacuubrand.com

Web: www.vacuubrand.com